



Community Experience Distilled

Raspberry Pi Home Automation with Arduino

Automate your home with a set of exciting projects for the Raspberry Pi!

Andrew K. Dennis

[PACKT]
PUBLISHING

www.it-ebooks.info

Raspberry Pi Home Automation with Arduino

Automate your home with a set of exciting projects for
the Raspberry Pi!

Andrew K. Dennis

[PACKT]
PUBLISHING

BIRMINGHAM - MUMBAI

Raspberry Pi Home Automation with Arduino

Copyright © 2013 Packt Publishing

All rights reserved. No part of this book may be reproduced, stored in a retrieval system, or transmitted in any form or by any means, without the prior written permission of the publisher, except in the case of brief quotations embedded in critical articles or reviews.

Every effort has been made in the preparation of this book to ensure the accuracy of the information presented. However, the information contained in this book is sold without warranty, either express or implied. Neither the author, nor Packt Publishing, and its dealers and distributors will be held liable for any damages caused or alleged to be caused directly or indirectly by this book.

Packt Publishing has endeavored to provide trademark information about all of the companies and products mentioned in this book by the appropriate use of capitals. However, Packt Publishing cannot guarantee the accuracy of this information.

First published: February 2013

Production Reference: 1290113

Published by Packt Publishing Ltd.
Livery Place
35 Livery Street
Birmingham B3 2PB, UK

ISBN 978-1-84969-586-2

www.packtpub.com

Cover Image by William Kewley (william.kewley@kbbs.ie)

Credits

Author

Andrew K. Dennis

Project Coordinator

Joel Goveya

Reviewer

Stefan Sjogelid

Proofreader

Stephen Swaney

Acquisition Editor

Erol Staveley

Indexer

Hemangini Bari

Commissioning Editor

Ameya Sawant

Graphics

Valentina D'silva

Aditi Gajjar

Technical Editors

Veronica Fernandes

Worrell Lewis

Nitee Shetty

Production Coordinator

Shantanu Zagade

Cover Work

Shantanu Zagade

About the Author

Andrew K. Dennis is an R&D software developer at Prometheus Research. Prometheus Research is a leading provider of integrated data management for research and is the home of HTSQL, an open source navigational query language for RDMS.

Andrew has a Diploma in Computing, a BS in Software Engineering, and is currently studying for a second BS in Creative Computing in his spare time.

He has over 10 years experience working in the software industry in the UK, Canada, and the USA. This experience includes e-learning courseware development, custom CMS and LMS development, SCORM consultancy, web development in a variety of languages, open source application development, blogging about the integration of web technologies with electronics for home automation, and punching lots of Cat5 cables.

His interests include web development, e-learning, 3D printing, Linux, the Raspberry Pi and Arduino, open source projects, home automation and the use of web technology in this sphere, amateur electronics, home networking, and software engineering.

Acknowledgement

I would like to thank my wife Megen for supporting me throughout this project and putting up with the piles of electronics and computer hardware dotted around the house. My parents, for their support with my interest in technology while growing up and over the subsequent years.

The Cooking Hacks team, for their great new Raspberry Pi to Arduino Bridge shield and the various contributors over on the Cooking Hacks forum for their insights.

The people at Prometheus Research, for making this a great and interesting place to work. Partyka Chevrolet, for giving me some experience on the hardware side of networking.

I would also like to thank Joel Goveya and Ameya Sawant at Packt Publishing for their guidance throughout this process, and Stefan Sjogelid for his technical insights and reviews.

About the Reviewer

Stefan grew up in the 1980s with the C64 and the Amiga home computers. The ambitious goal of the Raspberry Pi Foundation, bringing fun programming back to today's youth, resonated strongly with Stefan who immediately ordered his Raspberry Pi on the launch day itself. After much tinkering and learning a great deal about the unique properties of the Pi, he launched the "PiLFS" (<http://www.intestinate.com/pilfs>) website, which teaches readers how to build their own GNU/Linux distribution and applications that are particularly useful on the Raspberry Pi.

www.PacktPub.com

Support files, eBooks, discount offers and more

You might want to visit www.PacktPub.com for support files and downloads related to your book.

Did you know that Packt offers eBook versions of every book published, with PDF and ePub files available? You can upgrade to the eBook version at www.PacktPub.com and as a print book customer, you are entitled to a discount on the eBook copy. Get in touch with us at service@packtpub.com for more details.

At www.PacktPub.com, you can also read a collection of free technical articles, sign up for a range of free newsletters and receive exclusive discounts and offers on Packt books and eBooks.



<http://PacktLib.PacktPub.com>

Do you need instant solutions to your IT questions? PacktLib is Packt's online digital book library. Here, you can access, read and search across Packt's entire library of books.

Why Subscribe?

- Fully searchable across every book published by Packt
- Copy and paste, print and bookmark content
- On demand and accessible via web browser

Free Access for Packt account holders

If you have an account with Packt at www.PacktPub.com, you can use this to access PacktLib today and view nine entirely free books. Simply use your login credentials for immediate access.

Table of Contents

Preface	1
Chapter 1: An Introduction to the Raspberry Pi, Arduino, and Home Automation	7
What we will explore in this book	7
History and background of the Raspberry Pi	8
Raspberry Pi hardware specifications	9
Dimensions	10
3.5mm analog audio jack	10
Composite RCA port	10
Two USB 2.0 ports plus one micro USB	10
HDMI port	11
SD card port	11
256 MB/512 MB SDRAM shared with GPU	11
CPU	11
GPU	11
Ethernet port	12
GPIO pins	12
History and background of Arduino	12
Raspberry Pi to Arduino shield connection bridge	13
Shield specifications	13
XBee socket	14
Power source selector	14
UART	14
Digital GPIO pins	14
Serial Peripheral Interface (SPI) pins	15
In Circuit Serial Programmer (ICSP) connector	15
Power pins	15
Analog inputs	15
Raspberry Pi GPIO connector	15

Soldering	15
Writing software for the Arduino	16
What home automation is	17
A history of home automation	17
X10 – a standard is born	18
The dot.com boom and open source – a new set of technologies	19
Commercial products	20
Arrival of the Raspberry Pi	21
Summary	21
Chapter 2: Getting Started Part 1 – Setting up Your Raspberry Pi	23
The SD card – our Raspberry Pi's storage device	23
Pre-installed SD card versus a blank one	24
Setting up the SD card	24
Formatting our card	25
Formatting instructions for Windows 7	25
Formatting instructions for Mac OS X	26
Formatting instructions for Linux	27
BerryBoot – our tool for installing an operating system	28
Downloading the BerryBoot zip	28
Windows	28
Mac	28
Linux	29
Hooking up the Raspberry Pi	29
Downloading the right operating system	30
Installing Raspbian	31
Installation complete	34
Windows users	35
Mac and Linux users	36
Summary	37
Chapter 3: Getting Started Part 2 – Setting up Your Raspberry Pi to Arduino Bridge Shield	39
Raspberry Pi to Arduino bridge shield	39
Checking which version of the Raspberry Pi we have	40
Setting up the Raspberry Pi to Arduino shield and LED	41
Installing the software	42
The Arduino IDE	42
A quick look at the language	43
arduPi – a library for our Raspberry Pi and Arduino shield	45
Installing arduPi	45
Leafpad – a text editor	46

Blinking LED application	48
A guide to the code	49
Compiling and running our application	50
Summary	51
Chapter 4: Our First Project – A Basic Thermometer	53
<hr/>	
Building a thermometer	54
Setting up our hardware	54
An introduction to resistors	55
Thermistor	55
10K Ohm resistor	56
Wires	56
Breadboard	56
Connecting our components	56
Software for our thermometer	58
Geany IDE	58
Installing the IDE	58
An introduction to Makefiles	59
Thermometer code	61
Writing our application	61
Compiling and testing	68
What if it doesn't work	69
Up and running	70
Summary	70
Chapter 5: From Thermometer to Thermostat – Building upon Our First Project	71
<hr/>	
Safety first	72
Introducing the thermostat	72
Setting up our hardware	73
Relays	74
Connecting the relay	74
Setting up our software	75
A program to test the relay	75
Installing screen	77
cURL	79
Thermostat code	79
Testing our thermostat and fan	85
Attaching the fan	86
Starting your thermostat application	86
Debugging problems	87
Summary	87

Chapter 6: Temperature Storage – Setting up a Database to Store Your Results	89
SQLite	89
Installing SQLite Version 3.x	90
Creating a database	91
A table to record our temperature	91
A table to record our rooms	92
Writing some SQL	92
Apache web server	94
Setting up a basic web server	94
WSGI	97
Setting up WSGI	98
Creating a Python application to write to our database	100
Conclusion	104
HTSQL	104
Download HTSQL	105
Configuring HTSQL	106
Testing our Arduino shield with our database	108
Summary	109
Chapter 7: Curtain Automation – Open and Close the Curtains Based on the Ambient Light	111
Photoresistors	112
Motor shield and motors	112
Setting up the photoresistor	112
Wiring up the components	113
Testing the photoresistor with software	114
Debug	117
Setting up the motor shield	117
Wiring up the components	117
Curtain control application	119
Pulse Width Modulation	119
Threads	119
Writing our code	120
Debugging problems	125
Connecting to your blinds/curtains	125
Setting the timing	125
Attaching the hardware	126
Debugging problems	126
Summary	127

Chapter 8: Wrapping up	129
A brief review of what we have learned	130
Next steps	130
Prototyping Pi Plate	131
The wiringPi library	133
The Gertboard	134
Introduction to the Gertboard components	134
GPIO PCB expansion board	135
GPIO Pins	135
Motor controller	136
Open collector driver	136
Buffered I/O	136
Atmel ATmeg chip microcontroller	137
Convertors – analog to digital and digital to analog	137
Writing software for the Gertboard	137
Ideas for next step projects	138
Expanding the curtain automation tool to include temperature sensing	138
Changing the motor on the curtain automation project to a stepper motor	139
Switching lights on with a photoresistor	139
Holiday lights from LEDs	139
The future of home automation	139
3D printing	139
RFID chips	140
EEG headsets	140
Summary	141
Appendix: References	143
Raspberry Pi	143
Raspberry Pi to Arduino bridge shield	144
Linux	144
Python	145
C/C++	145
Arduino	145
SQL	146
HTSQL	146
Apache	146
Electronics	147
Packt Publishing titles	147
Home automation technology	147

Table of Contents

3D printing	148
EEG headsets	148
Miscellaneous resources	149
Index	151

Preface

The world of home automation is an exciting field that has exploded over the past few years with many new technologies in both the commercial and open source worlds. This book provides a gateway for those interested in learning more about the topic and building their own projects.

With the introduction of the Raspberry Pi computer in 2012, a small and powerful tool is now available to the home automation enthusiast, programmer, and electronic hobbyist that allows them to augment their home with sensors and software.

Combining the Raspberry Pi with the power of the open source Arduino platform, this book will walk you through several projects for building electronic sensors and introduce you to software that will record this data for later use.

What this book covers

Chapter 1, An Introduction to the Raspberry Pi, Arduino, and Home Automation, introduces you to the technologies used in this book and provides a background to the world of home automation.

Chapter 2, Getting Started Part 1 – Setting up Your Raspberry Pi, teaches you about the Raspberry Pi and how to set it up, ready to use on your projects.

Chapter 3, Getting Started Part 2 – Setting up Your Raspberry Pi to Arduino Bridge Shield, provides you with a guide to setting up your Raspberry Pi to Arduino bridge shield and downloading the necessary libraries.

Chapter 4, Our First Project – A Basic Thermometer, helps you to build a thermometer and introduces you to a variety of electronic components.

Chapter 5, From Thermometer to Thermostat – Building upon Our First Project, expands upon our Thermometer project, turning it into a working thermostat that can switch relays on and off.

Chapter 6, Temperature Storage – Setting up a Database to Store Your Results, explores storing data output from your Thermostat, and then accessing it via a web browser.

Chapter 7, Curtain Automation – Open and Close the Curtains Based on the Ambient Light, teaches you how to integrate motors into your projects for opening and closing blinds and curtains, using the skills learned in previous chapters.

Chapter 8, Wrapping up, provides an overview of other technologies you can use in your project and a look towards the future of home automation.

Appendix, References, lists a collection of links pointing you towards the resources used in this book and other interesting information.

What you need for this book

For this book, you will need the following components and software:

- A computer running Mac OS X, Windows, or Linux
- A Raspberry Pi computer
- An SD card
- HDMI cable
- Access to an HDMI television or HDMI computer monitor
- A USB keyboard and mouse
- USB power supply for the Raspberry Pi
- Cooking Hacks Raspberry Pi to Arduino bridge shield
- Electronics breadboard
- 10K resistor
- Thermistor
- Photo resistor
- Jumper wires with male connectors
- An LED
- 9V DC motor
- 9V battery with connector for screw terminals
- Arduino Motorshield
- A soldering iron
- A desoldering iron/gun

Other software required for the projects in this book will be downloaded from the Internet with step-by-step instructions in the relevant chapters.

Who this book is for

This book is aimed towards the amateur home automation enthusiast who has some basic skills in programming and is looking for some simple projects to get started with. An in-depth knowledge of electronics is not required, and the book provides a step-by-step guide to setting up components and software in each chapter.

No prior knowledge of the Linux operating system or the Raspberry Pi is needed, although exposure to these technologies will certainly be helpful.

Conventions

In this book, you will find a number of styles of text that distinguish between different kinds of information. Here are some examples of these styles, and an explanation of their meaning.

Code words in text are shown as follows: "The previous program contains two functions, `void setup()` and `void loop()`."

A block of code is set as follows:

```
void setup(void) {
    printf("Starting up thermometer \n");
    Wire.begin();
}
```

Any command-line input or output is written as follows:

```
mkdir arduPi
cd arduPi
```

New terms and **important words** are shown in bold. Words that you see on the screen, in menus or dialog boxes for example, appear in the text like this: "Select the **Accessories** option from the menu".

 Warnings or important notes appear in a box like this.]

 Tips and tricks appear like this.]

Reader feedback

Feedback from our readers is always welcome. Let us know what you think about this book – what you liked or may have disliked. Reader feedback is important for us to develop titles that you really get the most out of.

To send us general feedback, simply send an e-mail to feedback@packtpub.com, and mention the book title via the subject of your message.

If there is a topic that you have expertise in and you are interested in either writing or contributing to a book, see our author guide on www.packtpub.com/authors.

Customer support

Now that you are the proud owner of a Packt book, we have a number of things to help you to get the most from your purchase.

Downloading the example code

You can download the example code files for all Packt books you have purchased from your account at <http://www.PacktPub.com>. If you purchased this book elsewhere, you can visit <http://www.PacktPub.com/support> and register to have the files e-mailed directly to you.

Errata

Although we have taken every care to ensure the accuracy of our content, mistakes do happen. If you find a mistake in one of our books – maybe a mistake in the text or the code – we would be grateful if you would report this to us. By doing so, you can save other readers from frustration and help us improve subsequent versions of this book. If you find any errata, please report them by visiting <http://www.packtpub.com/support>, selecting your book, clicking on the **errata submission form** link, and entering the details of your errata. Once your errata are verified, your submission will be accepted and the errata will be uploaded on our website, or added to any list of existing errata, under the Errata section of that title. Any existing errata can be viewed by selecting your title from <http://www.packtpub.com/support>.

Piracy

Piracy of copyright material on the Internet is an ongoing problem across all media. At Packt, we take the protection of our copyright and licenses very seriously. If you come across any illegal copies of our works, in any form, on the Internet, please provide us with the location address or website name immediately so that we can pursue a remedy.

Please contact us at copyright@packtpub.com with a link to the suspected pirated material.

We appreciate your help in protecting our authors, and our ability to bring you valuable content.

Questions

You can contact us at questions@packtpub.com if you are having a problem with any aspect of the book, and we will do our best to address it.

1

An Introduction to the Raspberry Pi, Arduino, and Home Automation

This chapter provides an introduction to the Raspberry Pi, Arduino, and the subject of home automation.

We'll look at the history of the Raspberry Pi and how it came to be, as well as the Arduino platform - an open source microcontroller that provides developers with a means to interact with their surroundings, through a variety of sensors and motors.

Finally, we will wrap up the chapter by covering home automation and how technologies such as the Raspberry Pi have put the ability to build complex sensor based systems in the hands of the open source community.

Let's start by looking at what we will be covering in the coming chapters.

What we will explore in this book

We have a number of exciting projects ahead that will slowly introduce you to home automation via the technologies of the Raspberry Pi and Arduino. These projects include:

- Writing software to control hardware
- Building a thermometer using a thermistor
- Turning the thermometer into a thermostat using relays
- Controlling electric motors using a motor shield
- Writing software for storing sensor data generated by your projects

By completing each chapter in the book, you will gain a basic knowledge of building circuits and hardware for home automation projects. You will learn about writing software to both control your projects and record the data generated by them. Finally, we will look towards future projects you can build with your new skills.

Our next step is to learn a little about the background of the technologies we are going to be using. We will start with the Raspberry Pi.

History and background of the Raspberry Pi

From the first vacuum tube computers, to the tape and punch card machines of the '60s, and the first microprocessor mainframes of the '70s, computing had very much been the preserve of large businesses and university research departments. However, by the late '70s, with the release of the Apple II and earlier seeds planted by such technology as the TV Typewriter and Apple I, this was rapidly changing.

As the '80s rolled into view, the public saw low-cost home computers such as the ZX Spectrum and Commodore 64 hit the mass market and subsequently give birth to a whole generation of amateur programmers. By the '90s, these programmers, brought up on tinkering with their home computers and writing BASIC, were heading into academia and the computer industry, and helping to forge the dot.com boom with game, web, open source, and business technologies.

The genesis of the Raspberry Pi is in many ways linked to this. A group of computer scientists lead by *Eben Upton* at the University of Cambridge's Computer Laboratory in 2006 struck upon the idea of producing a cheap educational micro-computer geared towards the amateur computer enthusiast, budding students, and children. The aim was to help to provide the skills to future Computer Science undergraduate applicants that many of those applying in the '90s possessed, thanks to the home computers of the '80s.

However it would be another two years before the project became viable, and not until 2012 before the Raspberry Pi was being shipped out to the public.

The 2000s saw a huge growth in mobile computing technologies, a large segment of this being driven by the mobile phone industry. By 2005, ARM – a British manufacturer of CPU core components and a by-product of the '80s home computer company Acorn, had grown to where 98 percent of mobile phones were using their technology. This translated into around 1 billion CPU cores. ARM technology would later end up being featured on the Raspberry Pi with the ARM ARM1176JZF-S processor core being used.

During the same period, *Ebon Upton* designed several concepts for the Raspberry Pi and by 2008, thanks to a by-product of the increasing penetration of mobile phone technology, the cost of building a miniature, portable microcomputer with many of the multimedia functions that the public were accustomed to was becoming viable.

Thus the Raspberry Pi foundation was formed and set about the task of developing and manufacturing the Raspberry Pi computer.

By 2011, the first Alpha models were being produced and tested, and the public finally got to see what the Raspberry Pi was capable of.

Demos of Quake III Arena and full HD/1080p video showed that the tiny computer could pack a big punch for low cost.

Finally in 2012, the Raspberry Pi was ready for public consumption. Two versions of the Raspberry Pi were scheduled to be manufactured, namely models A and B, with B being released first.

The model A board which will not include an Ethernet port and will consume considerably less power than the model B was given a price tag of \$25.

The model B that includes an Ethernet port was given a target price of \$35 USD and manufacturing in China started. This would later be moved to the UK with Sony taking over the process.

After several setbacks, including the wrong Ethernet port being attached to the early batches and several compliance regulations having to be passed, the Raspberry Pi was making its way into the hands of tech enthusiasts across the globe to a great reception.

So what exactly does the Raspberry Pi Model B you're holding include?

Raspberry Pi hardware specifications

We will briefly go over some of the core components that make up the Raspberry Pi to give you a better feel for what it is capable of.

The Raspberry Pi is built off the back of the Broadcom BCM2835. The BCM2835 is a multimedia application processor geared towards mobile and embedded devices.

On top of this, several other components have been included to support USB, RCA, and SD card storage.

We will now look at some of the core-components of the Raspberry Pi board. The following figure highlights some of these with a description of each provided:

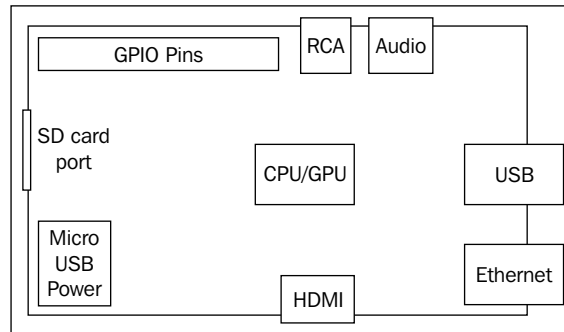

Dimensions

The Raspberry Pi is a small device coming in at 85.60mm x 53.98mm x 17mm and weighing only 45g. This makes it perfect for home automation, where a small device can be placed in a case and mounted inside an electrical box, or replace an existing thermostat device on a wall.

3.5mm analog audio jack

The 3.5mm analog audio jack allows you to connect headphones and speakers to the Raspberry Pi. This is especially useful for audio and media player based projects.

Composite RCA port

You are probably familiar with the composite cables used to hook up your DVD player to the TV. They usually come in the red, white, and yellow plug variety. The Raspberry Pi has a port for attaching the yellow video cable from your TV to it, allowing you to use your TV as a monitor.

Two USB 2.0 ports plus one micro USB

USB is one of the most common methods for connecting peripherals and storage devices to a computer. The Raspberry Pi comes equipped with two of them, allowing you to hook up a keyboard and mouse when you get started and a micro USB port for powering your device.

HDMI port

The **High Definition Multi-media Interface (HDMI)** port allows the Raspberry Pi to be hooked up to high-definition televisions and monitors that support the technology. This provides an additional option to the composite RCA port for video and additionally supports audio.

Should you wish to stream video and audio from the web to your TV, this is the port you would want to use.

SD card port

The main storage mechanism of the Raspberry Pi is via the SD card port. The SD card will be where we install our operating system and will act as our basic hard disk. Of course, this storage can be expanded upon using the USB ports.

256 MB/512 MB SDRAM shared with GPU

The Raspberry Pi comes equipped with 256 MB of SDRAM on older versions of the model B and 512 MB on the newer revisions. This isn't a huge amount, and much less than you would expect on a PC, where RAM is available in gigabytes. However, for the type of applications we will be building, 256 MB or 512 MB of RAM will be more than enough.

CPU

Early in this chapter we touched upon ARM - the British manufacturers of central processor unit (CPU) cores. The Raspberry Pi comes equipped with a 700 MHz, ARM1176JZF-S core - part of the ARM 11 32-bit multi-processor core family.

The CPU is the main component of the Raspberry Pi, responsible for carrying out the instructions of a computer program via mathematical and logical operations.

The Raspberry Pi is in good company using the ARM 11 series and has joined the ranks of the iPhone, Amazon Kindle, and Samsung Galaxy.

GPU

The graphics-processing unit (GPU) is a specialized chip designed to speed up the manipulation of image calculations.

In the case of our Raspberry Pi, it comes equipped with a Broadcom VideoCore IV capable of hardware accelerated playback and support for OpenGL.

This is especially useful if you want to run games or video via your Raspberry Pi, or work on 3D graphics in an open source application such as Blender.

Ethernet port

The Ethernet port is the Raspberry Pi's main gateway to communicating with other devices and the Internet. You will be able to use the Ethernet port to plug your Raspberry Pi into a home router such as the one you currently use to access the Internet, or a network switch if you have one set up.

GPIO pins

The General Purpose Input/Output (GPIO) pins on the Raspberry Pi are the main way of connecting with other electronic boards such as the Arduino.

As the name suggests, the GPIO pins can accept input and output commands and thus can be programmed on the Raspberry Pi.

The Arduino shields will be attached to the GPIO via a bridge shield allowing us to transfer data from sensors soldered to the device back to the Raspberry Pi. This is especially useful in home automation projects, where we may wish to store sensor data or manipulate motors based upon a program running on the Raspberry Pi's operating system.

Having touched upon the technical capabilities of the Raspberry Pi, we will now look at the Arduino and the Raspberry Pi to Arduino shield, a way to connect the two technologies via the GPIO pins.

History and background of Arduino

One of the most popular open source hardware products to have hit the market is the Arduino platform – a branch off of the earlier open-source Wiring platform. Developed in Italy by *Massimo Banzi* and *David Cuartielles* in 2005, Arduino is an open source hardware technology coupled with a programming language and an Integrated Development Environment (IDE).

The Arduino platform allows the user to create custom hardware and applications to control it via its namesake programming language.

Currently, there are several board models on the market ranging in size and components. For example, the Lilly Pad allows enthusiasts to attach an Arduino board to clothing for electronic textile-based projects. These boards support a wide range of "shields" – Arduino compatible electronic boards that can be plugged into it and expand its functionality. One particular extension has been the introduction of Ethernet shields and wireless Xbee devices to allow communication with home networks and the Web.

The benefit of the Arduino for amateur enthusiasts has been that little or no knowledge of how electronics are soldered together is required to use the pre-built shields. However, as the user becomes more comfortable with the technology, he/she can progress to building his/her own projects using the numerous kits and sensors available on the market.

This easy adoption has helped to contribute to the number of websites and books dedicated to home automation projects using the technology.

In this book, we will not be using one of the Arduino microcontroller boards, the Raspberry Pi will fulfill this role. However we will be using the Raspberry Pi to Arduino shield. This will allow us to connect shields and other components to the Raspberry Pi and control them via the Arduino programming language.

Raspberry Pi to Arduino shield connection bridge

For our project, the particular Raspberry Pi to Arduino shield we will be using is produced by Cooking Hacks, an offshoot of the Libelium wireless communications company based in Spain.

Their website can be found at <http://www.cooking-hacks.com>.

The Cooking Hacks shield is connected to the Raspberry Pi's GPIO pins, and with the inclusion of the **arduPi** software, you will be able to communicate between your electronic devices, the Raspberry Pi's operating system, and web-based projects.

Let's take a quick look at the shield and its components.

Shield specifications

The Raspberry Pi to Arduino shield is a credit card sized electronics board that mimics an Arduino microcontroller in its layout. The Raspberry Pi connector is under the board, and the top of the board contains typical pins and connectors you would find on an Arduino board such as the Uno.

The following figure highlights some of the key components of interest and a description of each is also listed:

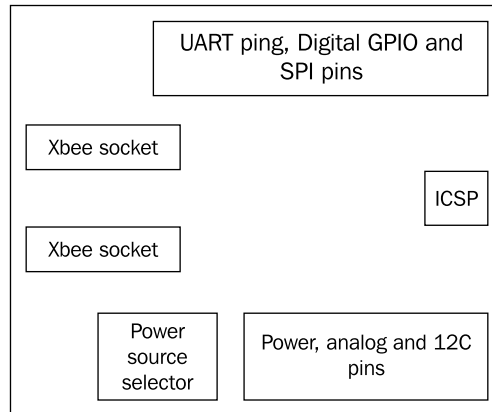

XBee socket

The two Xbee sockets on the shield provide support for Xbee wireless radio communication modules. Our Raspberry Pi comes equipped with an Ethernet port, so we will not need to use these for any of our home automation projects. If, however, you wish to switch out Ethernet for Xbee devices instead, these are the connectors you can use.

Power source selector

The power source selector is a small switch located on the side of the shield that can be used to enable an external power source.

UART

The **Universal Asynchronous Receiver/Transmitter (UART)** is the serial input and output port for your bridge shield and is marked with Rx and Tx. This can be used to transmit serial data, such as text and is useful for debugging code, for example.

Digital GPIO pins

The digital I/O pins provide a place where you can hook up other electronic components. For example, you can solder a temperature sensor to pin 2 and then, via the Arduino programming language, read the data transmitted from it.

Serial Peripheral Interface (SPI) pins

SPI pins can be used to connect a peripheral device to your Arduino shield. The SPI includes the **SCK** (Serial Clock), **MISO** (Master In Slave Out), and **MOSI** (Master Out Slave In) pins.

In Circuit Serial Programmer (ICSP) connector

The ICSP allows us to program the Arduino microcontroller. For our project, we will not need this, as the Raspberry Pi will be taking the place of the Arduino microcontroller.

Power pins

The power pins can be used when hooking up a device to the shield. For example, a device drawing power from the shield and writing data back to it will need to use one of the power options (5V or 3.3V) and also the grounding pin.

Analog inputs

The analog inputs can be used to hook up devices such as potentiometers (commonly found as twisting knobs for changing things such as volume), which send an analog signal to the shield.

This is the analog counterpart of the digital GPIO pins described earlier.

Raspberry Pi GPIO connector

The Raspberry Pi GPIO connector can be found on the bottom of the shield. This is where you will connect your Raspberry Pi to Arduino bridge shield to the Raspberry Pi's GPIO pins.

Soldering

Soldering is the process of attaching electronic components together using a heated metal filler (the solder), in order to allow the electrical current to flow between them.

At this point, it is worth mentioning that practicing some soldering before you start building the projects in this book is worth the effort, but not strictly necessary. If you are a novice, do not worry as there will be minimal soldering.

Also if you have any old PC hardware sitting around, like a graphics card no longer in use, you can practice un-soldering and re-soldering the components until you get comfortable with the process. These will also help you get used to handling the soldering iron and de-soldering tool.

Writing software for the Arduino

After you set up the Arduino shield and plug it into the Raspberry Pi, you will probably be wondering how to interact with it. After all, it has sensors and LEDs, but these are nothing without applications to control them in a meaningful manner.

Many software languages are available on the Raspberry Pi and we are interested in four. These are the Arduino programming language, Python, SQL, and HTSQL.

The Arduino programming language – a subset of C++ – provides us with a tool for programming Arduino compatible shields and the components connected to them. One benefit of using this technology is that there is a wealth of programs and libraries online that can be used for future projects. You will be using this language in the Geany IDE for writing the core applications that will be reading data from sensors attached to your projects.

The next language we will be using is Python. Python is a high-level programming language developed in the late '80s by *Guido Van Rossum* named after the popular comedy show *Monty Python's Flying Circus*.

This language allows you to build web and database applications that can be used to process the output of Arduino programs. We will be using Python to build a web application that can process data sent to it and then insert it via SQL (Structured Query Language) into an SQLite 3 database.

We will also use SQL for building the database that our Python script connects to. In conjunction with the SQLite database management system we will construct a repository for storing some of the results from our projects, for example, temperature data.

Finally we will also be using HTSQL (Hyper Text Structured Query Language) to provide a web interface to our database that is easy to query via the web browser.

HTSQL allows us to set up a server pointed to our database and then query it without having to write further server-side code.

Now that we have looked at our tools for building home automation systems, the Raspberry Pi and Arduino, lets look at what home automation is.

What home automation is

Having picked up this book, you may already have an idea of what home automation is, but just in case, we'll give you a quick overview of the subject and the open source technology that is driving many projects out there today.

Home automation is more than just a remote control for your TV! Examples include programming your DVR to record your favorite shows, setting the AC unit to come on when it reaches 76 degrees Fahrenheit, and installing a fancy alarm system that contacts the police in the instance of a break-in.

Also known as **domotics** (a portmanteau between domestic and informatics), home automation can be summed up as the mechanism of removing as much human interaction as technically possible and desirable in various domestic processes, and replacing them with programmed electronic systems – essentially the automation of the home and housework.

A history of home automation

Concepts for home and building automation were around for decades before becoming reality and featured in the writing of the 19th century sci-fi author *HG Wells*, comics, and cartoons such as the *Jetsons*. American industrialist *George Westinghouse* helped to pioneer the AC (Alternating Current) electrical system – which the X10 home automation standard would later run over – and in 1966, the company that bears his name, Westinghouse Electric, employed an engineer who developed what could arguably be called the first computerized home automation system – the ECHO IV.

The **Electronic Computing Home Operator (ECHO)** was featured in the April 1968 edition of *Popular Mechanics* and had been expanded from a set of spare electronics - both in the physical and literal sense, to include computing its founder Jim Sutherland's family household finances and storing their shopping lists, amongst an array of other tasks.

You can still read the original *Popular Mechanics* article online at Google books (http://books.google.com/books?id=AtQDAAAAMBAAJ&pg=PA77&source=gbs_toc_r&cad=2#v=onepage&q&f=false).

The ECHO never went commercial and through the '60s, hobbyists and a number of large companies such as Honeywell toyed with the idea of computerizing the home, however it was the '70s, much as with personal computing, that saw the birth of the modern era of home automation technology.

X10 – a standard is born

The beginning of modern home automation technology can be argued to be found with the introduction of the X10 technology standard. Conceived in 1975 by Pico Electronics, who later partnered with Birmingham Sound Reproducers, X10 laid out the framework for allowing remote control access of domestic appliances. The X10 standard was designed to allow transmitters and receivers to work over existing electrical wiring systems by broadcasting messages such as "turn off" and "turn on" via radio frequency bursts.

Three years later in 1978, X10 products began to make their way into stores geared towards electronics enthusiasts and shortly after, in the '80s, the CP-290 computer interface made its way into the market for the Mattel Aquarius computer.

The CP-290 unit allowed computers to communicate with X10 compatible appliances in the home. Over the years, support for Windows and Mac has been included, and gave those interested in home automation the ability to program their lighting systems, thermostats, and garage doors from their home computers.

As revolutionary as X10 has been, it unfortunately had a number of flaws. These included:

- Wiring and interference issues
- Commands getting lost in transmission
- Limited scope of products supporting X10
- Limited scope of commands available
- Slow speed of signal transmission
- Lack of encryption
- Lack of confirmation message without expensive two way devices

By the late '90s, home automation still hadn't penetrated the home market on a truly wide scale, however the technological advancements of the dot-com boom were providing a whole new set of tools, protocols, and standards that addressed many of the flaws that the X10 standard has been limited by.

The dot.com boom and open source – a new set of technologies

With the explosion of technologies that followed the birth of the web in the '90s, home computing and networking technologies were now available to the public and could easily and cheaply be installed at home. These technologies would later provide ideal candidates for pushing the boundaries of what could be achieved by home automation enthusiasts, and provide the industry with the tools for building smart home appliances and systems.

It was only a small step from *PC to PC communication* to *appliance to PC communication*.

Home networks running on Ethernet and later WiFi provided a mechanism that could allow computers and electronic appliances to communicate with one another across a home without needing to use the existing electrical wiring. In the case of WiFi, no extra cabling was required.

As protocols such as FTP and HTTP became the norm for accessing information across the Internet, hardware developers saw the opportunity to leverage these communications technologies in open source hardware devices. Whereas X10 appliances had no way of knowing if a signal had been successfully sent without the purchase of costly "two-way" devices, web technologies provide a whole framework for returning error codes and messages.

At approximately the same time as the Arduino platform we introduced earlier was being developed, the first tablet computers were beginning to be released. From 2005 until now, there has been an explosion in mobile, tablet, and smartphone devices. This growth has been commonly referenced to as the "post-PC" era.

These devices have provided mobile computing platforms that can run complex software and be small enough to fit in the user's pocket. As a result of this, applications have been developed for the iPhone and Android that allow the user to control consumer electronics such as the TV.

Due to their size, portability, and in some cases, low cost, they have provided the perfect platform for interfacing with home appliances and devices, and provided an extension to a medium the user is familiar with.

Alongside the explosion in hardware, there was also an equivalent explosion in software. One particular product of interest that we will look at is the open source Android operating system.

The Android OS is a Linux-based operating system geared towards mobile devices. As part of the Open Handset Alliance – a consortium of 84 companies operating in the mobile sphere, Google backed and eventually purchased the Android mobile operating system.

The aim has been to create an open source operating system that can compete with companies such as Apple, and provide a robust system that can work across multiple manufacturer devices.

As a result of this, commercial manufacturers of home appliances have begun to embed the technology and software into their products, and a generation of "smart-devices" has started to appear in stores around the world.

Commercial products

If you are interested in a smart refrigerator that can tell you the weather and keep track of your groceries, or an oven that can be controlled via your smartphone, then you are in luck.

Products such as the Samsung RF4289HARS refrigerator running Android and the LG smart washing machine are paving the way for smart homes by embracing open source and web-based technologies.

It is also not just appliances that are getting the makeover. Thermostat systems such as the Nest – a company founded by ex-Apple employees-are re-thinking how smart thermostats work.

Barcodes and QR codes on products now allow the consumer to scan them with their smartphone and download information directly from the web providing details on the item. This can be extended to allow scanning and inventory management of products in the home, recording data such as consume – by dates of products in the refrigerator, and dynamically generating shopping lists.

This combination of hardware, software, and information now provides the potential for the home to become part of "an Internet of Things" to quote *Kevin Ashton*.

Thanks to the open source and open-standard technology being used in these devices, it is easy to combine home-brew projects built with the Raspberry Pi and commercial products by companies such as LG, to build a smart home that creates a network of devices that can communicate with one another to combine the execution of tasks.

As we mentioned, home-brew systems such as the Raspberry Pi can form part of this network; let's now look at the effects of the arrival of the Raspberry Pi on the world of home automation.

Arrival of the Raspberry Pi

With the arrival of the Raspberry Pi and the Raspberry Pi to Arduino shield, a set of open source technologies now exist that combine the power of the PC, the communication and multimedia technologies of the web, the ability to interact with the environment of a microcontroller, and the portability of a mobile device.

This provides the perfect set of factors allowing us to build cheap devices for our homes that can interface with commercial devices, but can be tailored for our own needs while also providing a great tool for learning about technology.

For those familiar with Arduino devices, the Raspberry Pi combined with its shields provide an all-in-one medium for creating devices without the need for a separate PC or Mac – giving us an alternative to solutions that currently exist.

Also, thanks to the Raspberry Pi's mission of providing an educational tool for those interested in programming, the addition of the Arduino shield will provide a mechanism for those who wish to move from writing software that manipulates the Raspberry Pi, to software that manipulates their environment and provides a pathway for learning about electronics. This could have the positive effect of bolstering the ranks of home-brew and Maker clubs with an eye towards home automation and lead to an ever-greater diversity of tools being produced for the public.

Summary

In this chapter, we have familiarized ourselves with the Raspberry Pi and Arduino. We have also looked at some of the existing technologies used in home automation and their history.

Where as Sutherland's ECHO IV filled a room in his house, the Raspberry Pi fills a space not much larger than a credit card.

Home automation now seems to be taking the next step to becoming widely adopted, and the Raspberry Pi neatly fits into this world by providing those who want to customize control of their devices with an easy and a cheap tool for achieving it, and by also expanding what can be done with Arduino technology currently out in the market place.

With this in mind, we will get started on our first project- setting up the Raspberry Pi.

2

Getting Started Part 1 – Setting up Your Raspberry Pi

In this chapter, we will look at setting up the Raspberry Pi. In order to use your device you will need to start by installing an operating system onto an SD card. Once this is in place, you can then install extra software for writing code and for controlling devices which you connect to the GPIO pins.

There are several steps needed to get you up and running:

- Deciding whether to purchase an SD card with a pre-installed OS or a blank card
- Formatting the SD card
- Choosing the right version of Linux
- Installing the operating system
- Operating system configuration

Once we have completed these steps, we will be ready to get started with our home automation projects.

The SD card – our Raspberry Pi's storage device

An SD (**secure digital**) card is a form of portable high performance storage medium available for electronic devices ranging from cameras to PCs.

The Raspberry Pi comes equipped with an SD card slot allowing us to insert an SD card and use it as our devices' main storage mechanism, much like a hard disk on a PC.

While you can use other storage mechanisms such as a USB drive or USB external hard drive, the SD card is small and thus lends itself better to embedded devices such as those found in home automation projects.

There are a variety of brands of SD cards on the market, and they come in a range of sizes. The Raspberry Pi supports larger SD cards such as those with 64 GB of storage space. For the projects in this book, you should be using an SD card with a minimum of 2 GB storage.

We will now look at the options available with regards to purchasing an SD card pre-installed with the operating system and formatting and installing it ourselves.

Pre-installed SD card versus a blank one

Since the Raspberry Pi has been released, a number of websites are offering preloaded SD cards that come installed with one of the operating systems that are available for the Raspberry Pi.

These are a good option for amateur enthusiasts looking to get started with the Raspberry Pi, who do not want to go through the setup process and are happy with a pre-loaded single operating system.

For our project though, we are going to suggest that you purchase a blank SD card and follow the instructions in this chapter. After you have finished formatting the card, you will be introduced to an application called BerryBoot. BerryBoot allows you to choose which operating system you would like to install. This will set you up for future projects when you may wish to install more than one operating system or choose one, other than the option that comes on a pre-loaded card.

With this in mind though, if you do not have a home PC or Mac to use in order to format a blank SD card, we would recommend purchasing a pre-formatted card. This should come loaded with the Debian Wheezy Raspbian OS, as this is the version of Linux we will be using throughout the book.

Setting up the SD card

Before we can install our operating system, we need to set up the SD card. This involves formatting it to the FAT filesystem format first.

FAT (File Allocation Table) is a method used for recording which sectors of a disk files are stored in and which sectors are free to be written to. It has its origins in the 1970s where *Bill Gates* and *Marc McDonald* developed it for use on floppy disks. Due to its robustness and simplicity, it is still found on SD cards today and is the format we will need in order to run our operating system selection application.

After formatting the SD card, we will then install a program called BerryBoot. This allows us to install our operating system onto the SD card, which the Raspberry Pi will use.

So take your card and insert it into the SD card port on your laptop or PC and we will begin by formatting it.

Formatting our card

As explained in the preceding section, in order to install BerryBoot, we first need to format the SD card to FAT format. This is a fairly simple task and can be performed on your PC or Mac.

When purchasing an SD card, you may find it is already formatted to FAT as this format is popular with devices such as digital cameras. Many manufacturers ship the card so it is ready to go out of the box and no further formatting is required.

However, we have provided the following instructions for Windows 7, Mac OS X, and Linux so you can re-format the card if it is pre-formatted or currently has data on it, or format it for the first time if necessary.

As newer versions of operating systems are released, sometimes menus are moved around. In such instances, you can usually find out where the SD card formatting instructions are online via Google or via the operating system's help menu.

Formatting instructions for Windows 7

The instructions that follow will guide you through formatting your SD card under the Windows 7 operating system. Once complete, you will be ready to install BerryBoot onto your SD card.

1. Click on the **Start** button on the Windows taskbar.
2. From the **Start** menu, click on **Computer**.
3. You will now be presented with a window containing a left-hand panel listing items such as **Favorites**, **Libraries**, **Computer**, and **Network**. The right-hand panel will show your PC's storage devices.
4. From the list of devices in the right-hand panel, right-click on your SD card.
5. From the pop-up menu, left-click on **Format**.
6. You will now see the **Format Removable Disk** popup.
7. From the **File system** drop-down, select **FAT32 (Default)** if not already selected.
8. You can leave the other settings dropdowns as they are.

9. In the **Volume label** text entry field, type your SD card name as `RASPBERRYPI`.
10. Check the **Quick Format** checkbox.
11. You are now ready to format the card.
12. Click on the **Start** button.

Windows will now format your SD card using the preceding settings.

Once successfully formatted, you will be presented with a popup informing you that the process is complete.

Select **OK** to close the popup. You are now ready to install BerryBoot on your SD card.

Formatting instructions for Mac OS X

The steps that follow will walk you through formatting the SD card on a Mac OS X machine. Once complete, your SD card will be ready to copy over the BerryBoot application.

1. Open your **Applications** folder.
2. Select the **Utilities** folder icon.
3. From the open folder, now select **Disk Utility**.
4. The **Disk Utility** window will now open. On the left-hand side, you will see a list of **Disks**, **Volumes**, and **Disk Images**.
5. Select your SD card from the left-hand menu.
6. Once selected, you will be presented with information about the disk in the right-hand panel.
7. From this panel, select the **Erase** tab.
8. You will now be presented with a set of options for formatting your SD card.
9. From the **Format** drop-down menu, select **MS-DOS (FAT)**.
10. Name your SD card `RASPBERRYPI`.
11. We are now ready to format the card.
12. Click on the **Erase** button.

Mac OS X will now format your SD card using the specifications you provided.

You can now move onto the next step of installing BerryBoot.

Formatting instructions for Linux

For formatting an SD card in Linux, we are going to use the `mkdosfs` program via the terminal window.

There are a number of tools available for formatting and partitioning disks in Linux. The `mkdosfs` program formats a device to use an MS-DOS filesystem, for example FAT16 or FAT32.

For our project, we need the SD card formatted in FAT to install BerryBoot, so this tool is perfect for the job.

1. Load the terminal window.
2. Type the command `df -h` at the prompt.
3. You will now see a list similar to the following:

Filesystem	Size	Used	Avail	Capacity	Mounted on
<code>/dev/disk1</code>	465G	119G	345G	26%	<code>/</code>
<code>/dev/mmcblk0p2</code>	7.3G	671M	6.3G	10%	<code>/media/SDcard</code>

4. Find the filesystem name of your SD card and note it down.
5. Also note down the directory it's mounted on.
6. If you are not logged in as root, switch user to root using `su`.
7. In order to format the SD card, you will need to un-mount it. In order to do this, you will need to use the command `umount` and pass it the filesystem name you noted, for example, `umount /dev/mmcblk0p2`.
8. We can now use the `mkdosfs` command to format the SD card.
9. Type the following command:

```
mkdosfs /dev/mmcblk0p2 -F32
```

10. Your SD card will now be formatted to FAT(32).
11. Now remount the SD card using the filesystem name and mounted on name you recorded earlier.

```
mount /dev/mmcblk0p2 /media/SDcard
```

Your SD card is now formatted and ready for copying BerryBoot onto it.

BerryBoot – our tool for installing an operating system

There are several ways of installing the OS onto the SD card, but by far the easiest of them is BerryBoot.

BerryBoot is a Mac, Windows, and Linux compatible boot loader. It works by being unzipped onto a formatted SD card and then when the Raspberry Pi is powered up, it launches.

Once loaded it allows you to choose the operating system you would like to install and walks you through the process. The BerryBoot application also helps you to install multiple operating systems on a single SD card.

Downloading the BerryBoot zip

Our first task is will be to download the BerryBoot zip file. This can be found at <http://www.berryterminal.com/doku.php/berryboot>.

Find the download link on the page and download the zip file. The file is around 21.3 MB.

Depending on the operating system you have installed your PC/Mac, you may already have a zip/unzip application included.

If you do not have a zip/unzip application you can download the following for Mac, Windows, and Linux.

Windows

The following two applications are GUI-based unzip and zipping tools that can be installed on Windows:

- 7-zip: <http://www.7-zip.org/>
- WinZip: <http://www.winzip.com/>

Mac

For Mac OS X, you can use one of the following two applications. The popular Windows zip tool WinZip also has a Mac version.

- WinZip for Mac: <http://www.winzip.com/mac/>
- Archiver: <http://archiverapp.com/>

Linux

For Linux, one of the best tools for unzipping files is unzip. Depending on your Linux distribution, you can use the following command to install the unzip package.

For Red Hat Linux, Fedora, and RPM compatible versions of Linux:

```
yum install unzip
```

For Debian GNU/Linux versions:

```
apt-get install unzip
```

Once you have installed your unzip application, extract the contents of the BerryBoot zip file you downloaded to your SD card. Contained within the zipped file are the files that will be used when the Raspberry Pi boots up for the first time.

When the preceding process is complete, we are ready to connect up the Raspberry Pi and peripherals so we can install the operating system.

Hooking up the Raspberry Pi

We are now going to set up our Raspberry Pi's hardware. You will need to complete the following steps before attempting to power up the Raspberry Pi:

1. Eject the SD card from your PC/Mac and place it into the SD card port on your Raspberry Pi.
2. Plug your Raspberry Pi into your monitor.
3. Attach your keyboard and mouse to the Raspberry Pi via the USB ports.
4. Using a Ethernet cable, attach your modem/router to your Raspberry Pi's Ethernet port.

Once these steps are complete you can now power up your Raspberry Pi by connecting the power unit to it.

On your monitor, you should now see the BerryBoot **Welcome** screen. This tells us that we have successfully copied over the files to the SD card and can now configure our operating system selection.

Downloading the right operating system

We now need to choose from the variety of operating systems that are available to install the Raspberry Pi. For the purposes of our home automation project, we are going to use the operating system called Raspbian. There are several reasons for choosing this over another operating system.

Raspbian is based upon the Debian Wheezy Linux operating system and has been optimized for use with Raspberry Pi. *Mike Thompson* and *Peter Green* of raspbian.org developed it and while not an official product of the Raspberry Pi foundation, is the operating system the foundation recommends for beginners on their website.

For those of you not familiar with Linux, it is a group of open source operating systems that uses the Linux Kernel and provides an alternative to applications such as Windows.

Mac OS X users may be familiar that they are using a Unix-like operating system that gives them many of the command-line functionalities that Linux users are familiar with. They will also find some similarities with the Raspbian operating system, which we are installing on the Raspberry Pi.

There are several reasons for deciding to go with the Raspbian operating system that are listed as follows:

- Raspbian has a desktop environment similar to Windows and Mac called LXDE, so it provides an easy transition for those not familiar with Linux command line.
- It comes pre-installed with software that will be useful for writing code for the Raspberry Pi and Arduino such as Python. It also includes other software that you may be interested in exploring that has an educational bent. One example is Scratch, a tool for introducing programming to children.
- The operating system has been tailored to run on the Raspberry Pi. The code compilation is optimized for on-chip floating-point calculations (hard-float) rather than a slower software-based method.
- There is wide spread community support for the operating system, meaning that as you move forward with projects beyond this book, there will be plenty of resources as well as help available to you.

Next up is a walk through of the process of installing Raspbian and configuring some important settings.

Installing Raspbian

Once the Raspberry Pi is powered up, you will see the BerryBoot **Welcome** screen.

Follow the steps to install Raspbian.

From the **Welcome** popup, select the following settings:

1. If you have green borders at the top and bottom of your monitor, select the radio button titled **Yes (disable overscan)**.
2. From the **Network connection** option, select the **Wired** radio button.
3. From the **Locale settings**, select the appropriate options for the **Timezone** and **Keyboard layout** fields.
4. Once complete, select the **OK** button.
5. Once you have clicked on **OK**, you will be taken to the **Disk selection** screen. Here you will choose which storage device you want to install your operating system on.

If you have other storage devices beyond your SD card connected to the Raspberry Pi, you will also be given the option of using these. However we are going to use the SD card.

1. Select your SD card from the list and then change the **File system** select box to **ext 4 (no discard)**. Like FAT, `ext4` is a filesystem and in this instance is geared towards Linux.
2. Now select the **Format** button.
3. Once the formatting is complete, we are presented with the **Install operating system** screen from which we can choose Raspbian.

4. Click on the **Debian Wheezy Raspbian** option.

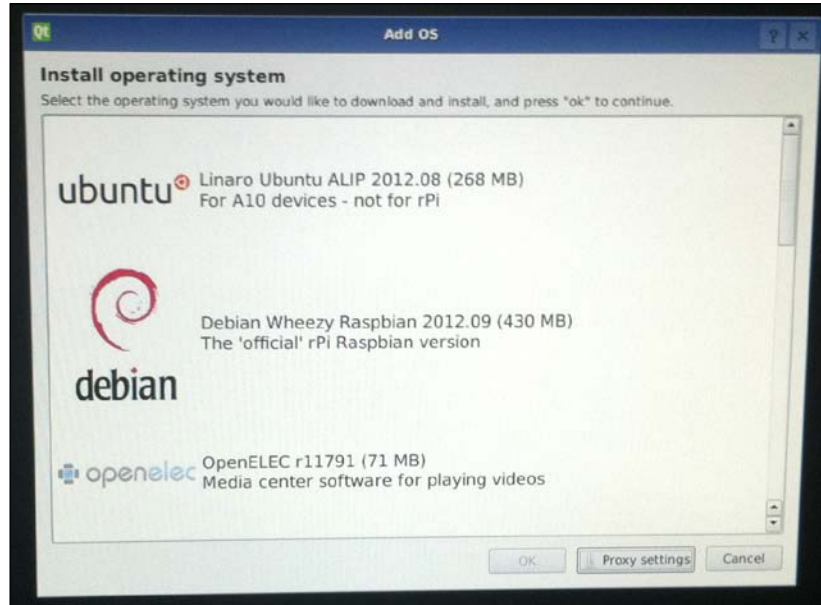

This download is around 430 MB and depending on the speed of your Internet connection, will take a few minutes.

Once complete, you will be presented with the **BerryBoot menu editor**. This is a screen with a menu and a list of operating systems currently installed on your SD card.

Providing you haven't previously added any operating systems on your SD card, there should be the one you just installed called **Debian Wheezy Raspbian** followed by the version number.

There are a number of options at the top of the **BerryBoot menu editor** screen. These are as follows:

- **Add OS**
- **Edit**
- **Clone**
- **Export**
- **Delete**

- **Make default**
- **Exit**
- And the [↵] icon, which will take you to the advanced settings option

For the purposes of this installation, we are only interested in the **Make default** and **Exit** options.

1. Select the operating system you installed and click on **Make default**. This will mean that the Raspbian operating system we installed is launched as the default option when the Raspberry Pi is started up.
2. Then select **Exit**.

You will now see the **Raspi-config** screen.

The **Raspi-config** screen is a menu that allows you to assign some values to the settings of your Raspberry Pi. You can navigate the screen using the arrows keys and use the *Enter* key to select an option.

The menu on this screen consists of the following:

- **Info**: Information about this tool
- **Overscan**: Change overscan
- **configure_keyboard**: Set keyboard layout
- **change_pass**: Change password for 'pi' user
- **change_locale**: Set locale
- **change_timezone**: Set timezone
- **memory_split**: Change memory split
- **overclock**: Configure overclocking
- **ssh**: Enable or disable SSH server
- **boot_behaviour**: Start desktop on boot?
- **Update**: Try to upgrade `raspi-config`
- **<Select>**: Select an option
- **<Finish>**: Finish using menu

From this menu, we are going to change the password, enable SSH, and start the desktop environment on loading.

1. First navigate to and select the **change_pass** menu option, and enter and re-enter your new password.



The default password for the Raspberry Pi is `raspberry`. If you plan on opening up your Raspberry Pi to the Internet to allow connections from outside your home network, then it is advisable to change the password to something strong.

After this, we need to set up **SSH** so that it allows us to connect to the Raspberry Pi remotely via the command line on a different machine.

2. Select the **ssh** option and enable the `ssh` server.
3. Finally, we want to change the boot behavior of the Raspberry Pi so that the desktop environment is started when the operating system boots up. To do this, change the **boot_behaviour** option to start desktop on boot.
4. We have now finished configuring the settings we need to on the **Raspi-config** screen and can exit, so now navigate to the **<Finish>** option and press the *Enter* key to complete your setup.

Installation complete

You have now successfully completed the Raspberry Pi setup and will see the Raspbian Linux desktop. This desktop contains a number of icons which will load the programs installed by default, including Midori, a fast and light web browser, and the Python IDE (integrated development environment), both of which we will be using.

Also of note is the LXTerminal. This icon launches the Linux terminal window, which allows us to run applications via the command line.

One optional final test you can perform is to connect to your Raspberry Pi via SSH.

There are several ways of getting the IP address assigned to your Raspberry Pi, one of which is to check the DHCP table on your home modem/router. However, an easier method is to check it on the Raspberry Pi itself.

To do this load up the LXTerminal again and type the following command:

```
ip addr show eth0
```

You can find your IP address after the word `inet`. For example:

```
Inet 192.168.1.22/24 brd 192.168.1.255 scope global eth0
```

You need the portion before the `/` that reads `192.168.1.22`.



An IP address is a way of assigning a unique identifier to a computer or device on a local network or Internet. The most common form of IP address at the moment is IPv4, which takes the format `192.168.1.0`. You may also encounter the newer IPv6 which has the `2001:0ab1:25b9:0047:0000:8a2e:0110:7444` format.

Once you have the IP address for your Raspberry Pi, you can try connecting to it from your other machine.

Mac and Linux users can use the terminal that comes shipped with their operating system. Windows users can download a terminal executable file called PuTTY from <http://www.chiark.greenend.org.uk/~sgtatham/putty/download.html>.

PuTTY provides Windows users with a terminal style window that they can use to connect to Linux machines.

Windows users

Follow the steps to set up PuTTY on your Windows machine:

1. Double-click on the `putty.exe` file to load the PuTTY configuration screen.
2. In the **Host Name (or IP address)** text entry field, add the IP address of your Raspberry Pi.
3. Enter `22` into the **Port** field and under **Connection type**, select **SSH**.
4. Finally click on **Open**.
5. You may see a pop-up box with the title **PuTTY Security Alert** and a message explaining the server's host key is not cached in the registry.
6. You can select the **Yes** button.
7. In the terminal window, you will now see the following message:
Login as:
8. Enter your Raspberry Pi user name, that is, `pi`.

9. You will now see another message asking for the password, for example:
`pi@192.168.1.122's password:`
10. Enter the password and press the *Enter* key.
You will now be logged into the Raspberry Pi.

Mac and Linux users

Once you have your Terminal application ready, you can connect via SSH to your Raspberry Pi using the following command:

```
ssh pi@192.168.1.122
```

You will be asked to enter your password and may see a message suggesting that the authenticity of the host can't be established, for example:

```
The authenticity of host '192.168.1.122 (192.168.1.122)' can't be
established.
RSA key fingerprint is f6:4a:38:4a:8b:c6:04:a9:bc:51:c3:af:fe:cb:78:e6.
Are you sure you want to continue connecting (yes/no)?
```

Type *yes* into the command line and press the *Enter* key.

You will then see the following message:

```
Warning: Permanently added '192.168.1.122' (RSA) to the list of known
hosts.
```

Once you have completed this and entered your password, you should see the command line for your Raspberry Pi.

You have now successfully tested the SSH server and if you wish, can now control your Raspberry Pi remotely from your second machine.

Summary

In this chapter, we have looked at what an SD card is, setting it up for use with the Raspberry Pi, installing an operating system, and loading up our Raspberry Pi for the first time.

There are many resources available online if you wish to explore the Raspbian operating system further. These include the following:

- <http://www.raspberrypi.org/>: The Raspberry Pi's official homepage
- <http://www.raspberrypi.org/phpBB3/>: The official Raspberry Pi forum
- <http://www.raspbian.org/>: Home of the Raspbian version of Linux
- <http://www.linux.org/>: A Linux education dedicated website

Now that we have the operating system in place, we can take a look at the Arduino to Raspberry Pi shield and getting it setup ready to use with the Raspberry Pi.

So grab your Cooking Hacks shield and let's get started.

3

Getting Started Part 2 – Setting up Your Raspberry Pi to Arduino Bridge Shield

In this chapter, we will look at the Raspberry Pi to Arduino shield. We will discuss identifying your Raspberry Pi model and installing the correct software library for it. Once you have followed these steps, we will briefly touch on the Arduino IDE to give you an idea of what the language looks like.

After this, we will write an application that turns an LED on and off, and then compile and run our application.

Raspberry Pi to Arduino bridge shield

In order to use the Raspberry Pi to Arduino shield, we will need to set it up. This is a two stage process involving the connection of our hardware and installing our software. In the process of setting up the hardware, we will also connect up an LED to a breadboard with two wires. This will act as our first test project to ensure that everything is working correctly.

For this chapter you will need the following components:

- Your connected up Raspberry Pi
- The Cooking Hacks Raspberry Pi to Arduino shield
- An electronics breadboard
- An LED
- Two wires for connecting the breadboard to the shield

Checking which version of the Raspberry Pi we have

In order to install the correct software package for our Cooking Hacks shield, we need to identify the version of the Raspberry Pi we have. The quickest and easiest way of doing this is to examine the Raspberry Pi board.

Version 2 Raspberry Pis have two mounting holes located on them and *Made in the UK* printed on the board. The earlier versions of the board have neither of these two items.

The Cooking Hacks website includes a guide to examining which version of the board you have. It can be found at <http://www.cooking-hacks.com/index.php/documentation/tutorials/raspberry-pi-to-arduino-shields-connection-bridge#step3>.

It is also possible to check the revision number via the command line, which in turn can be used to work out the board version. Typing the following command will show the hardware details of the Raspberry Pi:

```
cat /proc/cpuinfo
```

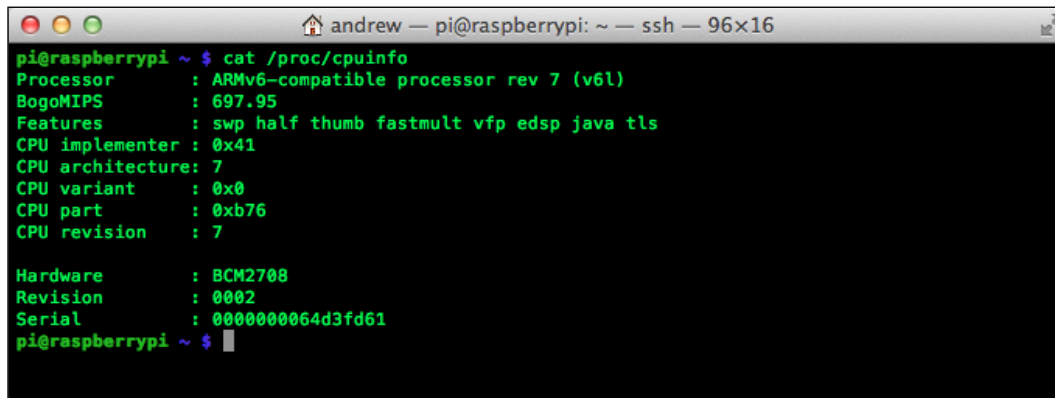

```
pi@raspberrypi ~ $ cat /proc/cpuinfo
Processor       : ARMv6-compatible processor rev 7 (v6l)
BogoMIPS       : 697.95
Features        : swp half thumb fastmult vfp edsp java tls
CPU implementer : 0x41
CPU architecture: 7
CPU variant     : 0x0
CPU part       : 0xb76
CPU revision    : 7

Hardware       : BCM2708
Revision      : 0002
Serial        : 0000000064d3fd61
pi@raspberrypi ~ $
```

Look for the revision entry where you will see the revision number; in the preceding screenshot, this is **0002**.

You can cross-reference the revision number with the Raspberry Pi documentation located on the Element 14 website (<http://www.element14.com/community/docs/DOC-42993/1/raspberry-pi-single-board-computer>).

Here you will find a table with a document link titled **Revision Note**. Clicking on this will take you to a document with the latest revision numbers present. This will then allow you to identify the board version.

Now that we have noted which version of the Raspberry Pi board we have, let's set up our hardware.

Setting up the Raspberry Pi to Arduino shield and LED

We will now walk through the process of connecting up the shield to the Raspberry Pi and hooking up the LED components.

Un-pack your shield and locate the black connector on the bottom of the board. Attach the shield via this to the GPIO pins on your Raspberry Pi. If you are unsure what these are, you can refer to the figure in the *Raspberry Pi hardware specifications* section in *Chapter 1, An Introduction to the Raspberry Pi, Arduino, and Home Automation*.

With the shield firmly attached to the Raspberry Pi, you can now hook up the LED.

Take two wires and attach one to the grounding pin and the second to the digital pin 2.

Place each of these into your breadboard. Now insert the LED into the breadboard so that the wire running from digital pin 2 is connected to the longer of the two legs on the LED and the ground pin is connected to the shorter of the two.

The following figure provides a guide to this setup:

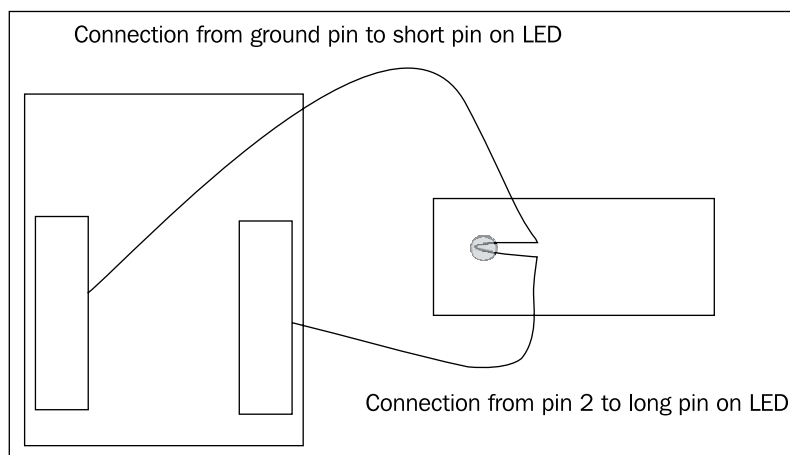

There is no need to solder any of the components at this time, as the LED application we are writing is purely to test that our setup is working correctly.

Once you have completed the hardware setup, we can then install the software needed to control our Raspberry Pi to Arduino shield.

Installing the software

In order to allow our Raspberry Pi to communicate with our Arduino shield, we will need to install the **arduPi** library.

The arduPi software is a set of custom C++ files written by the Cooking Hacks team that allows our applications written on the Raspberry Pi to interact with the shield via the functions commonly found in Arduino applications.

You will also be given the choice to install the Arduino IDE, although this is not necessary for any of the applications in this book. While we will not use the IDE for compiling programs, it will provide a useful resource for exploring existing programs. For those of you with an Arduino microprocessor, you will be able to use this in conjunction with your Raspberry Pi.

You will also use Leafpad to write your first application, and a simple method to compile and run your sketches from the command line.

The Arduino IDE

The optional step of installing the Arduino IDE can be performed using `apt-get`.

Open up your terminal window and run the following command to ensure `apt-get` is up-to-date:

```
sudo apt-get update
```

You should now see any packages that need updating being downloaded to your Raspberry Pi.

To download and install the IDE type the following command:

```
sudo apt-get install arduino
```

You will be prompted that the IDE will use several MB of disk space. You can select yes to this to complete the install.

The Arduino IDE will now be available via the start bar in Raspbian under the **Electronics** option. Navigate to the IDE link and open it on your Raspberry Pi. You should be presented with a window containing an empty pane. This empty pane is where you can write code and load examples. In the Arduino world, this is known as a sketch.

You will notice on the top menu a small play button with a triangle in it. When using the IDE to upload code to an Arduino board, this button is used to compile the code and upload it to the microcontroller.

Since we are using the Raspberry Pi instead of an Arduino, we will use a C++ compiler on the command line that will perform the role that the play button does in the IDE. We will cover this in more detail when we come to write our first application.

For experienced developers, there are a number of other tools available for creating and running Arduino applications. A list of them can be found at <http://arduino.cc/playground/Main/DevelopmentTools>.

If you own a Windows machine, there is also a plug-in for Visual Studio that allows you to modify the Arduino IDE skin and add your own buttons to it. You could therefore expand the IDE toolbar to run custom commands that build your Arduino sketch with the arduPi library.

In this chapter, we will use Leafpad to write our application and then compile it via the command line. In *Chapter 4, Our First Project – A Basic Thermometer*, we will look at the Geany IDE and Makefiles, which combine these functions.

A quick look at the language

We are going to quickly take a look at a simple program written in the Arduino language.

If you have installed the Arduino IDE, you can find the example using the following steps:

1. From the Main menu, select **File**.
2. Then select **Examples** from the examples menu.
3. Select **1.Basics**.
4. From this menu, select **Blink**.

The Blink example will now load.

If you have not installed the IDE, you can use the following code located in `Blink.ino`:

```
/*  
  Blink  
  Turns on an LED on for one second, then off for one second,  
  repeatedly.
```

```
This example code is in the public domain.
*/

void setup() {
  // initialize the digital pin as an output.
  // Pin 13 has an LED connected on most Arduino boards:
  pinMode(13, OUTPUT);
}

void loop() {
  digitalWrite(13, HIGH); // set the LED on
  delay(1000);           // wait for a second
  digitalWrite(13, LOW); // set the LED off
  delay(1000);           // wait for a second
}
```



Downloading the example code

You can download the example code files for all Packt books you have purchased from your account at <http://www.PacktPub.com>. If you purchased this book elsewhere, you can visit <http://www.PacktPub.com/support> and register to have the files e-mailed directly to you.

The Arduino language is a subset of C++, so we will be using Arduino specific functions that form the core of the language, in conjunction with standard C++ code in order to build our applications.

The previous program contains two functions, `void setup()` and `void loop()`.

Within `void setup()`, we can see the statement `pinMode(13, OUTPUT)`. This tells the application to set the pin labeled 13 on the Arduino board to output mode. If a device such as an LED is connected to pin 13, then it can be switched on and off.

The second function we can see is `void loop()`. The function executes continuously so any statements located within it will run in an infinite loop. Within this function you can see `digitalWrite(13, HIGH)` and `digitalWrite(13, LOW)`. These two commands switch the LED on and off creating a blinking effect. The `delay(1000)` statement causes a 1 second pause between each statement, so the LED does not blink too fast.

The Arduino programming language supports many features; you can see a full list of these in the Arduino documentation located online at <http://arduino.cc/en/Reference/HomePage>.

Now that we have briefly looked at the Arduino blink code, we will take this example and demonstrate how it works with our Raspberry Pi shield and the LED we connected to it.

arduPi – a library for our Raspberry Pi and Arduino shield

In order for the previous blink example to work with our Arduino shield, we need to install the arduPi library by Cooking Hacks. This library will allow us to write Arduino applications and use them on the Raspberry Pi without needing a separate microcontroller such as an Uno board.

So lets install the library and take a look at its contents.

Installing arduPi

Earlier in this chapter, we took note of which version of the Raspberry Pi board we are using. Based upon that version number, we are going to download one of two files, which contain the arduPi library.

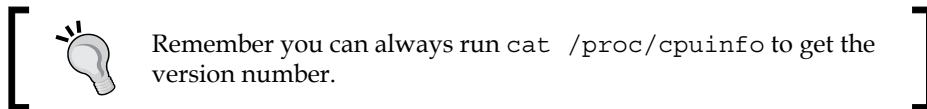

Open the terminal window on your Raspberry Pi and create a new directory in which to install the library and navigate to it.

```
mkdir arduPi
cd arduPi
```

If you have a Version 1 board, run the following command:

```
wget http://www.cooking-hacks.com/skin/frontend/default/cooking/
images/catalog/documentation/raspberry_arduino_shield/
arduPi_rev1.tar.gz
```

If you have Version 2, you will need the revision 2 gzip file.

```
wget http://www.cooking-hacks.com/skin/frontend/default/cooking/
images/catalog/documentation/raspberry_arduino_shield/
arduPi_rev2.tar.gz
```

After `wget` has run, a `tar.gz` file will be saved into the current directory.

From the terminal, run the following command, the `<revision version>` will be specific to the `tar.gz` you downloaded:

```
tar xzf arduPi_<revision version>.tar.gz
```

For example, if you downloaded revision 1, then you would type the following command:

```
tar xzf arduPi_rev1.tar.gz
```

Once the file has finished extracting, you will find three new files in the directory.

Type the following command to list the directories contents:

```
ls
```

You will now see the files `arduPi.cpp`, `arduPi.h`, and `arduPi_template.cpp`. The files `arduPi.cpp` and `arduPi.h` contain the code that will be used to provide support for interacting with your Arduino to Raspberry Pi shield. The `arduPi_template.cpp` provides a basic template file that you can use to create applications. The `arduPi.cpp` file will need to be compiled into an object file in order for us to use it. For this task, we will be using a C++ compiler.

From the command line, type the following command:

```
g++ -c arduPi.cpp -o arduPi.o
```

This command invokes the `g++` compiler, takes the `arduPi.cpp` as an input file, and outputs an object file called `arduPi.o`.

Now that we have the code compiled, lets take a look at the template files.

Leafpad – a text editor

Leafpad is a simple open source text editor similar to Notepad on Windows or TextEdit on the Mac. It is already installed in Raspbian, so is ready to use without any further setup.

To load Leafpad, you can access it via the following steps:

1. Click on the start button located on the bottom left of your Raspbian task bar.
2. Select the **Accessories** option from the menu.
3. Select the Leafpad icon from the list of applications.

Leafpad will now open, presenting you with a blank document.

Using the **Open** option under the **File** menu, load the `arduPi_template.cpp` file.

You will see the following in the `arduPi_template.cpp` file:

```
//Include ArduPi library
#include "arduPi.h"

//Needed for Serial communication
SerialPi Serial;
//Needed for accesing GPIO (pinMode, digitalWrite, digitalRead,
  I2C functions)
WirePi Wire;
//Needed for SPI
SPIPi SPI;

/*****
 * IF YOUR ARDUINO CODE HAS OTHER FUNCTIONS APART FROM *
 * setup() AND loop() YOU MUST DECLARE THEM HERE *
 * *****/

/*****
 * YOUR ARDUINO CODE HERE *
 * *****/

int main (){
  setup();
  while(1){
    loop();
  }
  return (0);
}
```

Looking at this file, we can see some similarities to the `Blink.ino` file we opened earlier. One main difference though is the inclusion of the `int main() {}` function. It is within this function that we reference the Arduino functions that are used to run an application. As you can see in the preceding code snippet, there is a reference to a `setup()` function and a `loop()` function.

The top of the file contains arduPi specific code that is needed to use the standard Arduino function calls such as the `digitalWrite()` function we saw in the Blink program.

When writing your own code, you can take a copy of the template file and insert your own setup and loop functions, as well as any other custom functions you wish to run.

We are now going to demonstrate this by combining the Blink example with the arduPi template.

Blinking LED application

Our next step is creating a custom application that combines the template code and the blink code, with some modifications to work with the LED we wired up earlier.

You can think of the blinking LED test as the electronics equivalent of the simple “Hello World” application you learn to write when starting a new programming language.

Open Leafpad and enter the following code in `Blink_test.cpp`:

```
//Include ArduPi library
#include "arduPi.h"

//Needed for Serial communication
SerialPi Serial;

//Needed for accessing GPIO (pinMode, digitalWrite, digitalRead,
  I2C functions)
WirePi Wire;

//Needed for SPI
SPIPi SPI;

int main (){
    setup();
    while(1){
        loop();
    }
    return (0);
}

void setup(){
    pinMode(2,OUTPUT); //set pin 2 on the shield as an output
}

//This function will run in an infinite loop
void loop(){
    digitalWrite(2,HIGH); //turn the LED on
    delay(1000); //wait a second
    digitalWrite(2,LOW); // dim the LED
    delay(1000); //wait another second
}
```

Now lets walk through this code to see what our application is doing.

A guide to the code

We will briefly go over the syntax we have used to create the blinking LED application. It should be familiar to you from looking at the `arduPi_template.cpp` and the Blink example.

First lets cover comments. Comments are notes in the code that will not be run by the compiler and are prefixed with two slashes `//` or enclosed in `/*` and `*/`. For example:

```
//Include ArduPi library
```

We can use these to document our code and note what each function is doing. These can be found located throughout the code, and we recommend that you include them when writing your own applications. They can be useful as a reminder when you revisit some code you haven't worked on for a while.

Next look at the top of the file. Here you can see an `include` statement:

```
#include "arduPi.h"
```

This tells the compiler to include the code located in the `arduPi.h` header file when we run the `g++` compiler and output our application. After this, we see some statements that allow the application to use the Arduino functions. An example of this being:

```
//Needed for accessing GPIO (pinMode, digitalWrite, digitalRead, I2C
functions)
WirePi Wire;
```

This block of code allows us to invoke functions that read and write to the digital pins on the shield. We will be using this in our LED example in order to write to pin 2 on the shield. Following this is the main function which calls `setup()` and then places the `loop()` function into a infinite `while` loop.

Our `setup` function contains a single statement that initializes pin 2 on the shield and sets it to output. When we set up our hardware at the beginning of the chapter, you will remember we connected via the breadboard the long leg of the LED to pin 2 on the shield.

Next we have the `loop()` function. This is called from inside the `while` loop located in the `main()` function. Inside the `loop` function, like we saw with the Blink example, there are four statements. Two of these are responsible for turning the LED on and off and the other statements creates a 1 second delay, so the LED has a blinking effect.

Now that we have an application we can use to control our LED, we need to compile and run it.

From the Leafpad file menu, select **File** then **Save As**. Save the file with the name `blink_test.cpp` to the same directory as your arduPi library and template. Exit Leafpad and via the terminal window, navigate to the arduPi directory you created. Inside this directory you should see the file you created called `blink_test.cpp`.

Now that we have saved our test application, we can compile and run it.

Compiling and running our application

If not already open, launch another terminal window.

In the window, make sure you are located in the arduPi directory and run the following command:

```
g++ -lrt -lpthread blink_test.cpp arduPi.o -o blink_test
```

The `g++` compiler will now compile our `blink_test.cpp` file and link it with the `arduPi.o` file, finally outputting a binary file called `blink_test`.

So we have created our file and compiled it. The next and final test is to run it. In the terminal window, type the following command:

```
sudo ./blink_test
```

You should now see the LED on the breadboard start to blink on and off with a one second interval.

[ Pressing *Ctrl + C* at any time in the terminal will exit the application.]

If the LED starts blinking, then the compilation and setup of your hardware has been successful!

Congratulations! You have written your first application using the Arduino programming language, compiled it, and ran it.

Now that the basics are out of the way and you have explored outputting to a pin on the shield, we can move onto more complex projects.

Summary

In this chapter, we have set up our Raspberry Pi to Arduino shield.

The software library for interacting with the Arduino shield is installed and ready for further projects. You have also been introduced to the Arduino programming language and C++ and learned how to compile code.

Following from this, you have written an application that turns an LED on and off.

Now that we have the basics of controlling components attached to our Raspberry Pi to Arduino shield, we can move onto our first home automation project – building a thermometer.

4

Our First Project – A Basic Thermometer

Now that we have our Raspberry Pi to Arduino shield set up, we can start to build projects using it.

In this chapter, we are going to build our first project with the Raspberry Pi and Arduino shield – a thermometer.

You will need the following hardware items for this chapter:

- Raspberry Pi
- The Raspberry Pi to Arduino shield
- A thermistor
- The breadboard and wires we used to test the LED
- A 10k resistor

From a software standpoint, you will also be introduced to the Geany IDE and the Linux `make` command. Using these tools, we will write an application that converts the resistance returned from the circuit into three types of temperature, namely Celsius, Kelvin, and Fahrenheit.

The key concepts we will be covering will form a basis that will be expanded upon in the next chapter, *Chapter 5, From Thermometer to Thermostat – Building upon Our First Project*.

Building a thermometer

A thermometer is a device used for recording temperatures and changes in temperatures.

The origins of the thermometer go back several centuries, and the device has evolved over the years. Traditional thermometers are usually glass devices that measure these changes via a substance such as mercury, which rises in the glass tube and indicates a number in Fahrenheit or Celsius.

The introduction of microelectronics has allowed us to build our own digital thermometers. This can be useful for checking the temperature in parts of your house such as the garage or monitoring the temperature in rooms where it can affect the contents, for example, a wine cellar.

Our thermometer will return its readings to the Raspberry Pi and display them in the terminal window.

Lets start by setting up the hardware for our thermometer.

Setting up our hardware

There are several components that you will need to use in this chapter. You can solder the items to your shield if you wish or use the breadboard if you plan to use the same components for the projects in the chapters that follow.

Alternatively, you may have decided to purchase an all-in-one unit that combines some of the following components into a single electronic unit.

We will make the assumption that you have purchased separate electronic components and will discuss the process of setting these up.

We recommend that you switch Raspberry Pi off while connecting the components, especially if you plan on soldering any of the items.



If your device is switched on and you accidentally spill hot solder onto an unintended area of the circuit board, this can short your device, damaging it. Soldering while switched off allows you to clean up any mistakes using the de-soldering tool.

An introduction to resistors

Let's quickly take a look at resistors and what exactly these are.

A resistor is an electronic component with two connection points (known as terminals) that can be used to reduce the amount of electrical energy passing through a point in a circuit. This reduction in energy is known as **resistance**.

Resistance is measured in **Ohms (Ω)**. You can read more about how this is calculated at the Wikipedia link [http://en.wikipedia.org/wiki/Ohm's_law](http://en.wikipedia.org/wiki/Ohm%27s_law). You will find resistors are usually classified into two groups, fixed resistors and variable resistors.

The typical types of fixed resistor you will encounter are made of carbon film with the resistance property marked in colored bands, giving you the value in Ohms.

Components falling into the variable resistance group are those with resistance properties that change when some other ambient property in their environment changes. You will be exploring some of these throughout the book.

Let's now examine the two types of resistors we will be using in our circuit - a thermistor and a 10K Ohm resistor.

Thermistor

A thermistor is an electronic component which, when included in a circuit, can be used to measure temperature. The device is a type of resistor that has the property whereby its resistance varies as the temperature changes. It can be found in a variety of devices, including thermostats and electronic thermometers.

There are two categories of thermistors available, these being **Negative Thermistor Coefficient (NTC)** and **Positive Thermistor Coefficient (PTC)**. The difference between them is that as the temperature increases the resistance decreases in the case of a NTC, or increases in the case of a PTC.

There are two numerical properties that we are interested in with regards to using this device in our project. These are the resistance of the thermistor at room temperature (25 degrees Celsius) and the beta coefficient of the thermistor. The coefficient can be thought of as the amount the resistance changes by as the ambient temperature around the thermistor changes. When you purchase a thermistor, you should have been provided with a datasheet that lists these two values. If you are unsure of the resistance of your thermistor, you can always check it by hooking it up to a voltage detector and taking a reading at room temperature. For example, if you bought a 10K thermistor, you should expect a reading of around 10K Ohms. For this project, we recommend purchasing a 10K thermistor.

10K Ohm resistor

A 10K Ohm resistor, unlike a thermistor, is designed to have a constant resistance regardless of temperature change. This type of device falls into the fixed resistor category. You can tell the value of a resistor by the colored bands located on its body. When you purchase resistors, you may find they come with a color-coding guide, otherwise you can check the chart on Wikipedia (http://en.wikipedia.org/wiki/Electronic_color_code#Resistor_color_coding) in order to ascertain what the value is.

As part of the circuit we are building, you will need the 10K resistor in order to convert the changing resistance into a voltage that the analog pin on your Raspberry Pi to Arduino can understand.

Wires

For this project, you will require three wires. One will attach to the 5V pin on your shield, one to the ground, and finally, one to the analog 0 pin.

In the wiring guide, we will be using red, black, and yellow wires. The red will connect to 5V pin, the black to ground, and the yellow to the analog 0 pin.

Breadboard

Finally, in order to connect our component, we will use the breadboard as we did when connecting up the LED.

Connecting our components

Setting up our components for the thermometer is a fairly easy task. Once again, at this point, there is no need to attempt any soldering if you plan on re-using the components.

Follow these steps in order to connect up everything in the correct layout.

1. Take the red wire and connect it from the 5V pin on the shield to the connect point on the bus strip corresponding to the supply voltage.



There are often two bus strips on a breadboard. These can be found on either of the long sides of the board and often have a blue or red strip indicating supply voltage and ground.

2. Next take the black wire and connect it from the ground pin to the ground on the breadboard.
3. We are now going to hook up the resistor. Connect one pin of your 10K resistor to the supply voltage strip that your red wire is connected to and take the other end and connect it to a terminal strip.

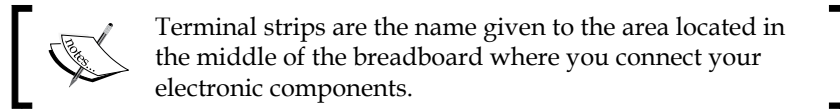

4. Now that the resistor is in place, our next task will be to connect the thermistor.
5. Insert one leg/wire of the thermistor into the ground on the bus strip, and place the second leg into the same row as you placed the resistor.
6. The thermistor and resistor are daisy-chained together with the supply voltage. This leaves us now with the final task, which is connecting up the analog pin to our daisy chain.
7. Finally connect one end of your yellow wire from the analog 0 (A0) on your shield to the terminal strip you selected for the preceding components.

Sanity check

The setup of your circuit is now complete. However, before switching on your Raspberry Pi check that you have connected up everything correctly. You can compare your setup to the following diagram:

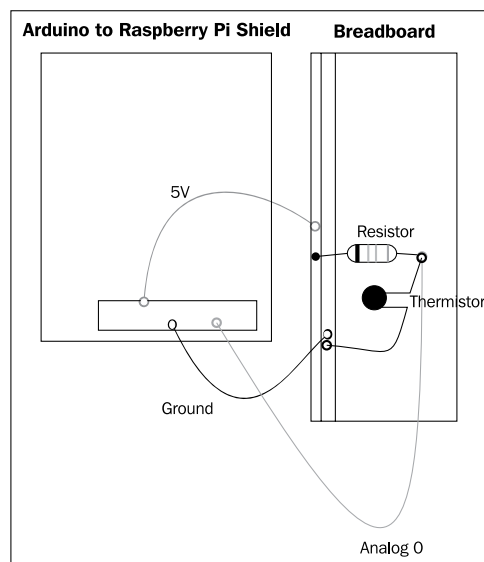

Our thermometer circuit is now complete, and you can now boot up your Raspberry Pi.

Of course, without any software to return readings to the screen, the circuit is little more than a combination of electronic components!

So let's get started on the software portion of our project.

Software for our thermometer

Now that we have the hardware for our thermometer, we will need to write some code that is capable of converting the values returned from the thermistor into a readable temperature in Celsius and Fahrenheit.

First up, we are going to look at a new code editing application. This IDE allows you to develop code in the Raspberry Pi X Window System environment and compile the code via a Makefile. We will start by looking at the Geany IDE.

Geany IDE

Geany is a lightweight Linux integrated development environment. It can be installed onto Raspbian and then used for writing code in the Arduino/C++ programming language. An added benefit of using this IDE is that we can set up a custom Makefile with the commands we have been using to compile arduPi-based projects.

By combining the Makefile and Geany, we have an IDE that mimics the functionality we would use in the Arduino IDE, but with the added benefit we can save files without renaming them and compile our applications with one click.

Installing the IDE

We are going to use the apt-get tool to install Geany on to your Raspberry Pi.

1. Start off with loading up your Terminal window. From the prompt, run the following command:

```
sudo apt-get install geany
```
2. You'll get the prompt alerting you to the fact that Geany will take up a certain amount of disk space. You can accept the prompt by selecting **Y**.
3. Once complete, you will now see Geany located under the **Programming** menu option.

4. Select the Geany icon from the previous menu to load the application.
5. Once loaded, you will be presented with a code-editing interface.
6. Along the top of the screen, you can find a standard toolbar. This includes the **File** menu where you can open and save files you are working on, and menus for **Edit, Search, View, Document, Project, Build, Tools, and Help**.
7. The left-hand side of the screen contains a window that has a number of features including allowing you to jump to a function when you are editing your code.
8. The bottom panel on the screen contains information about your application when you compile it. This is useful when debugging your code, as error messages will be displayed here.

Geany has an extensive number of features which are out of the scope of discussion for this book. However, you can find a comprehensive guide to the IDE at the Geany website <http://www.geany.org/>.

For our application development at this stage, we are only interested in creating a new file, opening a file, saving a file, and compiling a file.

The options we need are located under the **File** menu item and the **Build** menu item. Feel free though to explore the IDE and get comfortable with it.

In order to use the make option for compiling our application under the **Build** menu, we need to create a Makefile – we will now take a look at how to achieve this.

An introduction to Makefiles

The next tool we are going to use is the Makefile. A Makefile is executed by the Linux command `make`. Make is a command-line utility that allows you to compile executable files by storing the parameters into a Makefile and then calling it as needed. This method allows us to store common compilation directives and re-use them without having to type out the command each time.

As you are familiar with, we have used the following command in order to compile our LED example:

```
g++ -lrt -lpthread blink_test.cpp arduPi.o -o blink_test
```

Using a Makefile, we could store this and then execute it when located in the same directory as the files using a simpler command.

```
make
```

We can try out creating a Makefile using the code we wrote in the previous chapter. Load up Geany from the programming menu if you don't currently have it open. If you don't have a new document open, create a new one from the **File** menu. Now add the following lines to `Blink_test/Makefile`, making sure to tab the second line once:

```
Blink: arduPi.o
    g++ -lrt -lpthread blink_test.cpp arduPi.o -o blink_test
```



If you don't tab the second line containing the compilation instructions, then the Makefile won't run.

Now that you have created the Makefile, we can save and run it with the following steps:

1. From the **File** menu, select **Save**.
2. From the **Save** dialog, navigate to the directory where you saved your `blink_test.cpp` and save the file with the title `Makefile`.
3. Now open the `blink_test.cpp` file from the directory where you saved your Makefile.

You should see the code we wrote in *Chapter 3, Getting Started Part 2 – Setting up Your Raspberry Pi to Arduino Bridge Shield*. We can test our Makefile by selecting the **Build** option from the menu and selecting **Make**.

In the panel at the bottom of the IDE, you will see a message indicating that the Makefile was executed successfully.

4. Now from the Terminal window, navigate to the directory containing your `blink_test` project. Located in this directory, you will find your freshly compiled `blink_test` file.
5. If you still have your LED example at hand, hook it up to the shield and from the command line, you can run the application by typing the following command:

```
./blink_test
```

The LED should start blinking.

Hopefully, you can see from this example that integrating the Makefile into the IDE allows us to write code and compile it as we go in order to debug it. This will be very useful when you start to work on projects with greater complexity.

Once we have written the code to record our temperature readings, we will re-visit the Makefile and create a custom one to build our thermometer application via Geany.

Now that you have set up Geany and briefly looked at Makefiles, lets get started with writing our application.

Thermometer code

We will be using the arduPi library for writing our code as we did for the LED test. As well as using standard Arduino and C++ syntax, we are going to explore some calculations that are used to return the results we need.

In order to convert the values we are collecting from our circuit and convert them into a readable temperature, we are going to need to use an equation that converts resistance into temperature. This equation is known as the Steinhart-Hart equation.

The Steinhart-Hart equation models the resistance of our thermistor at different temperatures and can be coded into an application in order to display the temperature in Kelvin, Fahrenheit, and Celsius. We will use a simpler version of this in our program (called the B parameter equation) and can use the values from the datasheet provided with our thermistor in order to populate the constants that are needed to perform the calculations.

For a simpler version of the equation, we only need to know the following values:

- The room temperature in Kelvin
- The co-efficient of our thermistor (should be on the data sheet)
- The thermistor resistance at room temperature

We will use Geany to write our application, so if you don't have it open, start it up.

Writing our application

From the **File** menu in Geany, create a new blank file; this is where we are going to add our Arduino code. If you save the file now, then Geany's syntax highlighting will be triggered making the code easier to read.

Open the **File** menu in Geany and select **Save**. In the **Save** dialog box, navigate to the arduPi directory and save your file with the name `thermometer.cpp`. We will use the `arduPi_template.cpp` as the base for our project and add our code into it.

To start, we will add in the `include` statements for the libraries and headers we need, as well as define some constants that will be used in our application for storing key values. Add the following block of code to your empty file, `thermometer.cpp`, in Geany:

```
//Include ArduPi library
#include "arduPi.h"
//Include the Math library
#include <math.h>

//Needed for Serial communication
SerialPi Serial;

//Needed for accessing GPIO (pinMode, digitalWrite, digitalRead,
//I2C functions)
WirePi Wire;

//Needed for SPI
SPIPi SPI;

// Values need for Steinhart-Hart equation
// and calculating resistance.
#define TENKRESISTOR 10000 //our 10K resistor
#define BETA 4000 // This is the Beta Coefficient of your thermistor
#define THERMISTOR 10000 // The resistance of your thermistor at room
//temperature
#define ROOMTEMPK 298.15 //standard room temperature in Kelvin
//(25 Celsius).

// Number of readings to take
// these will be averaged out to
// get a more accurate reading
// You can increase/decrease this as needed
#define READINGS 7
```

You will recognize some of the preceding code from the arduPi template, as well as some custom code we have added. This custom code includes a reference to the Math library.

The Math library in C++ contains a number of reusable complex mathematical functions that can be called and which would help us avoid writing these from scratch. As you will see later in the program, we have used the logarithm function `log()` when calculating the temperature in Kelvin.

Following are a number of constants; we use the `#define` statement here to initialize them:

- **TENKRESISTOR:** This is the 10K Ohm resistor you added to the circuit board. As you can see, we have assigned the value of 10,000 to it.
- **BETA:** This is the beta-coefficient of your thermistor.
- **THERMISTOR:** The resistance of your thermometer at room temperature.
- **ROOMTEMPK:** The room temperature in Kelvin, this translates to 25 degrees Celsius.
- **READINGS:** We will take seven readings from the analog pin and average these out to try and get a more accurate reading.

 The values we have used previously are for a 10K thermistor with a co-efficient of 4000. These should be updated as necessary to reflect the thermistor you are using in your project.

Now that we have defined our constants and included some libraries, we need to add the body of the program.

From the `arduPi_template.cpp` file, we now include the main function that kicks our application off.

```

/*****
 * IF YOUR ARDUINO CODE HAS OTHER FUNCTIONS APART FROM *
 * setup() AND loop() YOU MUST DECLARE THEM HERE      *
 * *****/

/*****
 * YOUR ARDUINO CODE HERE *
 * *****/

int main (){
  setup();
  while(1){
    loop();
  }
  return (0);
}

```

 Remember that you can use both `//` and `/* */` for commenting your code.

We have our reference to the `setup()` function and to the `loop()` function, so we can now declare these and include the necessary code.

Below the `main()` function, add the following:

```
void setup(void) {
    printf("Starting up thermometer \n");
    Wire.begin();
}
```

The `setup()` function prints out a message to the screen indicating that the program is starting and then calls `Wire.begin()`. This will allow us to interact with the analog pins.

Next we are going to declare the `loop` function and define some variables that will be used within it.

```
void loop(void) {

    float avResistance;
    float resistance;
    int combinedReadings[READINGS];
    byte val0;
    byte val1;

    // Our temperature variables
    float kelvin;
    float fahrenheit;
    float celsius;

    int channelReading;
    float analogReadingArduino;
```

As you can see in the preceding code snippet, we have declared a number of variables. These can be broken down into:

- **Resistance readings:** These are `float avResistance`, `float resistance`, and `byte val0` and `byte val1`. The variables `avResistance` and `resistance` will be used during the program's execution for recording resistance calculations. The other two variables `val0` and `val1` are used to store the readings from analog 0 on the shield.
- **Temperature calculations:** The variables `float kelvin`, `float fahrenheit`, and `float celsius` as their names suggest are used for recording temperature in three common formats.

After declaring these variables, we need to access our analog pin and start to read data from it.

Copy the following code into your `loop` function:

```

/*****

ADC mappings

Pin Address

0  0xDC
1  0x9C
2  0xCC
3  0x8C
4  0xAC
5  0xEC
6  0xBC
7  0xFC
*****/

// 0xDC is our analog 0 pin
Wire.beginTransmission(8);
Wire.write(byte(0xDC));
Wire.endTransmission();

```

Here we have code that initializes the analog pin 0. The code comment contains the mappings between the pins and addresses so if you wish, you can run the thermistor off a different analog pin.

We are using pin 0, so we can now start to take readings from it. To get the correct data, we need to take two readings of a byte each from the pin. We will do this using a `for` loop.

 The Raspberry Pi to Arduino shield does not support the `analogRead()` and `analogWrite()` functions from the Arduino programming language. Instead we need to use the `Wire` commands and addresses from the table provided in the comments for this code.

Add the following `for` loop below your previous block of code:

```
/* Grab the two bytes returned from the
   analog 0 pin, combine them
   and write the value to the
   combinedReadings array
*/

for(int r=0; r<READINGS; r++){
  Wire.requestFrom(8,2);
  val0 = Wire.read();
  val1 = Wire.read();
  channelReading = int(val0)*16 + int(val1>>4);
  analogReadingArduino = channelReading * 1023 /4095;
  combinedReadings[r] = analogReadingArduino;
  delay(100); }
```

Here we have a loop that grabs the data from the analog pin so we can process it.

In the `requestFrom()` function, we pass in the declaration for the number of bytes we wish to have returned from the pin. Here we can see we have two – this is the second value in the function call. We will combine these values and then write them to an array; in total, we will do this seven times and then average out the value.

You will notice we are applying a calculation on the two combined bytes. This calculation converts the values into a 10-bit Arduino resolution. The value you will see returned after this equation is the same as you would expect to get from the `analogRead()` function on an Arduino Uno if you had hooked up your circuit to it.

After we have done this calculation, we assign the value to our array that stores each of the seven readings.

Now that we have this value, we can calculate the average resistance. For this, we will use another `for` loop that iterates through our array of readings, combines them, and then divides them by the value we set in our `READINGS` constant.

Here is the next `for` loop you will need to accomplish this:

```
// Grab the average of our 7 readings
// in order to get a more accurate value
avResistance = 0;
for (int r=0; r<READINGS; r++) {
  avResistance += combinedReadings[r];
}
avResistance /= READINGS;
```

So far, we have grabbed our readings and can now use a calculation to work out the resistance. For this, we will need our `avResistance` reading, the resistance value of our 10K resistor, and our thermistor's resistance at room temperature.

Add the following code that performs this calculation:

```
/* We can now calculate the resistance of
   the readings that have come back from analog 0
*/
avResistance = (1023 / avResistance) - 1;
avResistance = TENKRESISTOR / avResistance;
resistance = avResistance / THERMISTOR;
```

The next part of the program uses the resistance to calculate the temperature. This is the portion of code utilizing the simpler version of the Steinhart-hart equation. The result of this equation will be the ambient temperature in degrees Kelvin.

Next add the following block of code:

```
// Calculate the temperature in Kelvin
kelvin = log(resistance);
kelvin /= BETA;
kelvin += 1.0 / ROOMTEMPK;
kelvin = 1.0 / kelvin;
printf("Temperature in K ");
printf("%f \n",kelvin);
```

So we have our temperature in degrees K and also have a `printf` statement that outputs this value to the screen. It would be nice to also have the temperature in two more common temperature formats, those being Celsius and Fahrenheit.

These are simple calculations to perform. Let's start by adding the Celsius code.

```
// Convert from Kelvin to Celsius
celsius = kelvin - 273.15;
printf("Temperature in C ");
printf("%f \n",celsius);
```

Now that we have the temperature in degrees Celsius, we can print this to the screen. Using this value we can convert Celsius into Fahrenheit.

```
// Convert from Celsius to Fahrenheit
fahrenheit = (celsius * 1.8) + 32;
printf("Temperature in F ");
printf("%f \n",fahrenheit);
```

Great! So now we have the temperature being returned in three formats. Let's finish up the application by adding a delay of 3 seconds before the application takes another temperature reading and close off our `loop()` function.

```
// Three second delay before taking our next
// reading
delay(3000);
}
```

So there we have it. This small application will use our circuit and return the temperature. We now need to compile the code so we can give it a test.

Remember to save your code now so that the changes you have added are included in the `thermometer.cpp` file.

Our next step is to create a Makefile for our thermometer application. If you saved the `blink_test` Makefile into the arduPi directory, you can re-use this or you can create a new file using the previous steps.

Place the following code into your Makefile:

```
Thermo: arduPi.o
    g++ -lrt -lpthread thermometer.cpp arduPi.o -o thermometer
```

Save the file with the name `Makefile`.

We can now compile and test our application.

Compiling and testing

When discussing Geany earlier, we demonstrated how to run the `make` command from inside the IDE. Now that we have our Makefile in place, we can test this out.

1. From the **Build** menu, select **Make**.

You should see the compilation pane at the bottom of the screen spring to life and providing there are no typos or errors in your code, a file called `thermometer` will be successful output.

The `thermometer` file is our executable that we will run to view the temperature.

2. From the terminal window, navigate to the arduPi directory and locate your `thermometer` file.
3. This can be launched using the following command:

```
sudo ./thermometer
```

The application will now be executed and text similar to the following in the screenshot should be visible:

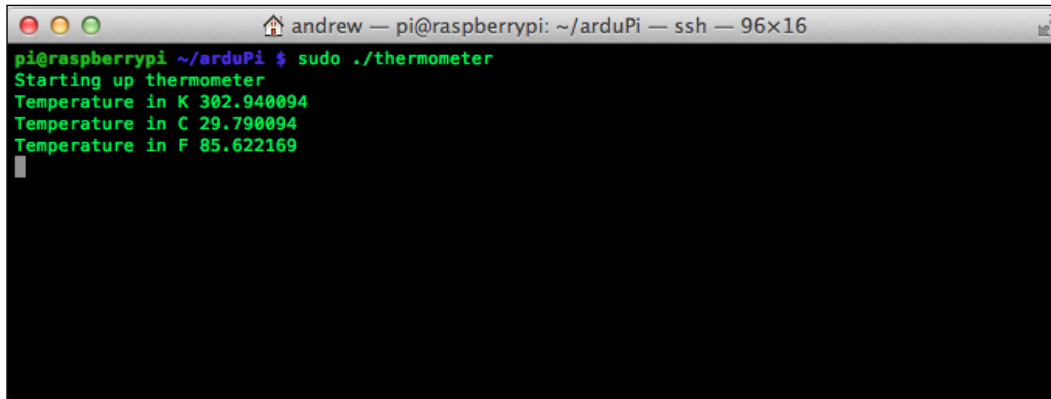

```

andrew — pi@raspberrypi: ~/arduPi — ssh — 96x16
pi@raspberrypi ~/arduPi $ sudo ./thermometer
Starting up thermometer
Temperature in K 302.940094
Temperature in C 29.790094
Temperature in F 85.622169

```

Try changing the temperature by blowing on the thermometer, placing it in some cold water if safe to do so, or applying a hair dryer to it. You should see the temperature on the screen change.

If you have a thermostat or similar in the room that logs the temperature, try comparing its value to that of your thermometer to see how accurate it is.



You can run an application in the background by adding an `&` after the command, for example, `sudo ./thermometer &`. In the case of our application, it outputs to the screen, so if you attempt to use the same terminal window your typing will be interrupted! To kill an application running in the background, you can type `fg` to bring it to the foreground and then press `Ctrl + C` to cancel it.

What if it doesn't work

Providing you had no errors when compiling your code, then the chances are that one of your components is not connected properly, is connected to the wrong pin, or may be defective.

Try double-checking your circuit to make sure everything is attached and hasn't become accidentally dislodged. Also ensure that the components are wired up as suggested at the beginning of this chapter.

If everything seems to be correct, you may have a faulty component. Try substituting each item one at a time in the circuit to see if it is a bad wire or faulty resistor.

Up and running

If you see your temperature being output successfully, then you are up and running! Congratulations, you now have a basic thermometer. This will form the basis for our next project, which is a thermostat.

As you can see, this application is useful. However, returning the output to the screen isn't the best method, it would be better for example, if we could see the results via our web browser or an LCD screen.

Now that we have a circuit and an application recording temperature, this opens up a wide variety of things we can do with the data, including logging it or using it to change the heat settings in our homes.

This chapter should have whetted your appetite for bigger projects.

Summary

In this chapter, we learned how to wire up two new components – a thermistor and resistor. Our application taught us how to use these components to log a temperature reading, and we also became familiar with Makefiles and the Geany IDE.

Let's move on to a more complex project using the skills we have gained from building your thermometer. In the next chapter, you will be using the same components you used previously and also expanding upon the application you wrote.

5

From Thermometer to Thermostat – Building upon Our First Project

In this chapter, we look at building a thermostat device. This will build upon our previous chapter where we learned how to use a thermistor.

We will cover how to use the temperature data to switch relays on and off. Relays are the main component that you can use to interact between your Raspberry Pi and high voltage electronic devices.

Our example project will involve switching on an electric fan when the temperature rises above a set point of 15 degrees Celsius and then switching it off when the temperature drops. We can use an ice cube and a hair dryer, or a similar device to stimulate the thermistor.

Upon completion of this chapter, you will have a thermostat device that you can use in your home to control a variety of devices beyond the fan example.

Finally, we will also write some code that will be ready to send data to the database that we will create in *Chapter 6, Temperature Storage – Setting up a Database to Store Your Results*.

For this chapter, you will need:

- Your Raspberry Pi and Arduino shield
- The thermometer device you built in *Chapter 4, Our First Project – A Basic Thermometer*
- Arduino compatible relay shield/component

- A small low voltage electric desktop fan
- Some wire cutters and strippers
- A way of stimulating the thermistor for both cold and hot temperatures, for example, some ice and a hair dryer.

Safety first

In this chapter, we will be using a device plugged into mains electricity (usually AC)—the fan. We will also be cutting the cable that connects the fan to the plug socket. This cable will be run through our relay circuit.

It is important to remind you at this point that working with mains electricity is dangerous. You should only attempt the fan portion of this project if you feel 100 percent confident in your ability to safely attach the thermostat device to the mains.

Also it is important that you select the correct relays for your electrical system. Attempting to use a 130 V AC relay on a 240 V AC electrical system, for example, can result in melting your device or worse.

Depending on your country of residence, the mains voltage can be between 110 V and 240 V. Before attempting this project, we recommend you read up on your electric system. Wikipedia provides an overview of mains electricity that you can use as a starting point:

http://en.wikipedia.org/wiki/Mains_electricity

Feel free to build the thermostat device and stop when it comes to the final steps of wiring it up if you do not feel comfortable with your ability. You can always revisit this project at a later date if you wish.

With that said, let's explore what a thermostat does.

Introducing the thermostat

A **thermostat** is a control device that is used to manipulate other devices based upon a temperature setting. This temperature setting is known as the **setpoint**. When the temperature changes in relation to the setpoint, a device can be switched on or off.

For example, let's imagine a system where a simple thermostat is set to switch an electric heater on when the temperature drops below 65 degrees Fahrenheit.

Within our thermostat, we have a temperature-sensing device such as a thermistor that returns a temperature reading every few seconds. When the thermistor reads a temperature below the setpoint (65 degrees Fahrenheit), the thermostat will switch a relay "on", completing the circuit between the wall plug and our electric heater and providing it power. Thus, we can see a simple electronic thermostat can be used to switch on a variety of devices.

Warren S. Johnson, a college professor in Wisconsin, is credited with inventing the electric room thermostat in the 1880s. Johnson was known throughout his lifetime as a prolific inventor who worked in a variety of fields including electricity. These electric room thermostats became common features in homes across the course of the twentieth century as larger parts of the world came to be hooked up to the electricity grid.

Now with open source electronic tools such as the Raspberry Pi and Arduino available, we can build custom thermostats for a variety of home projects. They can be used to switch on baseboard heaters, control heat lamps, and turn on air conditioner units. It can also be used for the following:

- Fish tank heaters
- Indoor gardens
- Electric heaters
- Air conditioning
- Fans

Now that we have explored the uses of thermostats, let's take a look at our project.

Setting up our hardware

This project builds up on our last project by reusing the thermometer we created. The thermometer is a key component of our thermostat as we use this to test the ambient temperature and switch the device connected to our Raspberry Pi on/off based upon this.

We will start by explaining the relay device.

Relays

A relay is a type of switch controlled by an electro-magnet. It allows us to use a small amount of power to control a much larger amount, for example using a 9 V power supply to switch 220 V wall power. Relays are rated to work with different voltages and currents; for example, the Seeed Arduino shield's relays can work with up to 130 V of AC power.

A relay has three contact points; these are **Normally Open**, **Common Connection**, and **Normally Closed**. Two of these points will be wired up to our fan. In the context of an Arduino project, the relay will also have a pin for ground, 5 V power and a data pin that is used to switch the relay on and off.

Connecting the relay

Depending on the relay device you purchased for your Raspberry Pi, there are several ways to connect the relays to the Arduino shield. The method that follows relies on your relay being connected to a digital input, the 5 V power, and ground.

For those of you using a relay shield in the thermostat program, we have moved the connection of the thermistor from analog 0 to analog 7, as this pin is located on an area of the board not used by a third-party shield.

Carry out the following steps to connect your relay:

1. Connect a wire from your Arduino to Raspberry Pi shield's 5 V power to the power pin on your relay's board.
2. If necessary you can use the breadboard and connect the wire from the supply voltage strip to the board. If you are using a relay shield, then the pin will automatically be connected to the 5 V power pin.
3. Take another wire and connect this from the ground on your shield to the ground on your relay. Once again, you can use the breadboard as an intermediary, or if you are using a shield, this is automatically taken care of by a header pin.
4. We will now connect the data pin. Run a wire from a digital data pin, for example 4, to the relay. If you are using a shield, then all of the data pins will be connected.
5. If your thermometer is not already connected, reconnect it to the shield, this time running the data wire to analog 7 instead of analog 0.

Finally, if your relay requires an external power supply, connect this. Your circuit, when connected, should look similar to the following diagram:

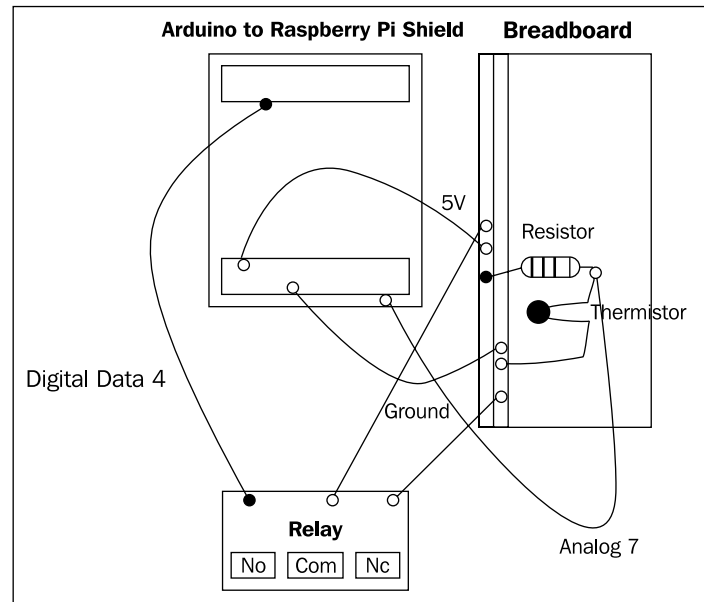

This circuit makes up the core of our thermostat. For the moment, we will not connect the fan to the relay but work on the software needed to run the thermostat.

We will also quickly test our relay to make sure everything is connected correctly.

Setting up our software

Let's start with writing a simple program that opens and closes a relay connected to the Raspberry Pi. Once we have confirmed this works we can then modify the application we wrote in the previous chapter to switch the relays on and off and construct a URL to post the data to the web.

A program to test the relay

Load up Geany and add the following program to a file called `Relay.cpp` in the same directory as your `arduPi` library:

```
//Include ArduPi library
#include "arduPi.h"

//Needed for Serial communication
```

```
SerialPi Serial;

//Needed for accessing GPIO (pinMode, digitalWrite, digitalRead,
  I2C functions)
WirePi Wire;

//Needed for SPI
SPIPi SPI;
/*****
 * IF YOUR ARDUINO CODE HAS OTHER FUNCTIONS APART FROM *
 * setup() AND loop() YOU MUST DECLARE THEM HERE      *
 * *****/

/*****
 * YOUR ARDUINO CODE HERE *
 * *****/

int main (){
    setup();
    while(1){
        loop();
    }
    return (0);
}

void setup(){
    pinMode(4,OUTPUT);
}

void loop()
{
    digitalWrite(4,HIGH);
    delay(1000);
    digitalWrite(4,LOW);
    delay(1000);
}
```

As you can see, this program uses the `arduPi_template.cpp` file that you should be familiar with by now.

 You may notice that this program is the same as `blink_test.cpp` using pin 4 instead of 2

Within the `setup()` function, we declare digital pin 4 as an output. Following this in the `loop()` function, we switch the relay on and then off with a second between each command. Save this file and now create a new empty file. We will use this for our Makefile. To the new file you created, add the following:

```
Relay: arduPi.o
      g++ -lrt -pthread Relay.cpp arduPi.o -o Relay
```

Save this file with the name `Makefile` and then run it from the Build menu. Once completed, you can then run the application from the command line in the `arduPi` directory.

```
./Relay
```

If you listen to the relay, you should hear a "clicking" sound. This is the relay opening and closing. This indicates that the relay is hooked up correctly and ready for us to write the thermostat program. Next up, we are going to install an application onto Raspbian called `screen`. `Screen` allows us to run multiple "windows" within a terminal session that are not shut down when we close this session down.

For example, if you now close the terminal window running your relay application, then you will hear the "clicking" sound of the relay stop. Ideally, we would like to be able to close down a terminal window or end a shell session and leave our application running.

Installing screen

`Screen` can be installed via `apt-get`. From the command line, run the following:

```
sudo apt-get install screen
```

Once `screen` has completed installing, we are going to change a few settings to make it easier to use.

Open up a new file in Geany and add the following configuration:

```
hardstatus on
hardstatus alwayslastline
hardstatus string "%{B}%-Lw%{c}%50>%n%f*%t%{-}%+Lw%<"
defmonitor on
shelltitle w # Rename with ctrl-a A
```

This configuration allows us to give a title to each of the "windows" we create in a `screen` session and display this title at the bottom of the terminal window. We will now see this in action.

Save this file to the root of your home directory with the name `.screenrc`. In the terminal window, type the following command:

```
screen
```

You will now see the screen welcome message. You can press Space bar to exit. We can now rename this window session from within screen by performing the following key command:

Ctrl + A then *Shift + A*

Name this window `Test screen`. Now perform the following command:

Ctrl + A, C

This will create a second window. Name this window `Thermostat`. Your screen session should look similar to the following screenshot:

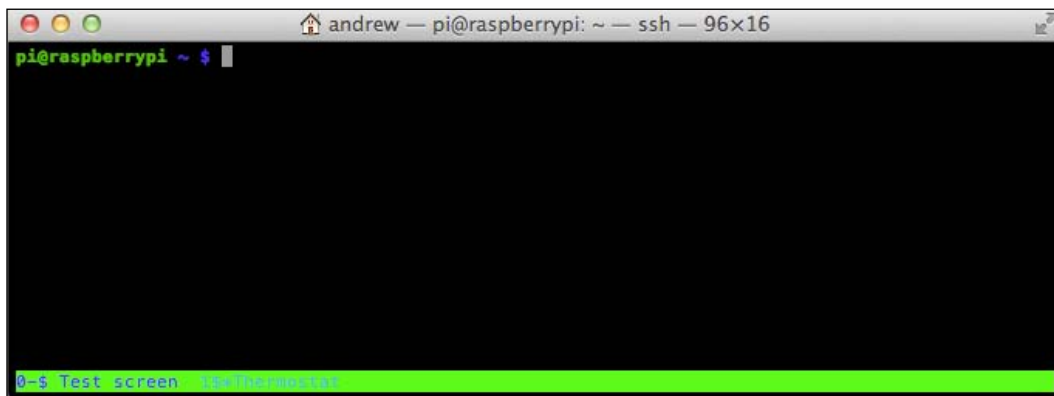

Pressing *Ctrl + A, N* will help you switch between the two windows. You've now seen how we can create windows, rename them, and switch between them. Finally, let's close the **Test** screen that we created. Switch to this window and then type `exit`. This window will now close, and you will be taken back to the thermostat window.

[ Pressing *Ctrl + A, D* will detach you from an existing screen session.]

If you need to reconnect to an existing screen session, type: `screen -r` in the command line. There is an extensive manual for screen that can be accessed via the `man screen` command.

If you need to load multiple applications, you can create a new screen for each and run them from within it, allowing you to switch between them and close them as necessary. When we launch our thermostat application, we will demonstrate how to leave the application running when exiting the terminal session.

cURL

We are now going to briefly look at cURL. Originally standing for "Client for URLs", this technology allows us to craft URLs in our code and then execute them.

For example, if we want to connect to a Python application from our script and pass it some of the values of the variables we have generated such as our temperature reading, we can use cURL by installing the `libcurl` developer headers.

In fact, this example is exactly what we will be doing with our code in *Chapter 6, Temperature Storage – Setting up a Database to Store Your Results* when we build a database application to accept the data we generate.

Raspbian comes with cURL installed by default, however, we will need to add the development library – `libcurl4-openssl-dev` via `apt-get`. Load up your screen window and navigate to the directory where you are developing your code and follow these steps:

1. Type the following command into your terminal:
`sudo apt-get install libcurl4-openssl-dev`
2. When prompted that the install will use disk space, type *Y* and press *Enter* to continue.

Now we have `libcurl` developer headers installed, we can build our thermostat code. Make a copy of your thermometer code and name it `thermostat.cpp`.

Thermostat code

We will now modify the thermostat code to switch our relay on and off when the temperature changes and to create a URL with the temperature data located in it.

Modify your new `thermostat.cpp` file as follows:

```
//Include ArduPi library
#include "arduPi.h"
//Include the Math library
#include <math.h>
//Include standard io
#include <stdio.h>
//Include curl library
#include <curl/curl.h>
```

In the preceding block of code, we have included the `stdio.h` file and the `curl.h` file. The `stdio.h` file provides us with some tools for string manipulation.

```
//Needed for Serial communication
SerialPi Serial;

//Needed for accessing GPIO (pinMode, digitalWrite, digitalRead,
  I2C functions)
WirePi Wire;

//Needed for SPI
SPIPi SPI;

// Values need for Steinhart-Hart equation
// and calculating resistance.
#define TENKRESISTOR 10000 //our 10K resistor
#define BETA 4000 // This is the Beta Coefficient of your thermistor
#define THERMISTOR 10000 // The resistance of your thermistor at
  room temperature
#define ROOMTEMPK 298.15 //standard room temperature in Kelvin (25
  Celsius).

// Number of readings to take
// these will be averaged out to
// get a more accurate reading
// You can increase/decrease this as needed
#define READINGS 7

// Relay Pin
#define RPIN 4

// Setpoint
#define SETPOINT 15.0
```

We have added two new constants to our code – `RPIN` and `SETPOINT`. `RPIN 4` is the digital pin that our relay is connected to. The `SETPOINT` constant is the value we will use as a base for switching the fan on and off.

```
/*
 * IF YOUR ARDUINO CODE HAS OTHER FUNCTIONS APART FROM
 * setup() AND loop() YOU MUST DECLARE THEM HERE
 * */
/

/*
```

```
* YOUR ARDUINO CODE HERE *
* *****/
```

```
boolean running = false; // A flag to let us know if the thermostat
is running
```

The running variable is a flag that we will switch to true or false depending on whether the fan is running or not.

```
int main (){
    setup();
    while(1){
        loop();
    }
    return (0);
}
```

```
void setup(void) {
    printf("Starting up thermostat \n");
}
```

The message output has been updated to read "thermostat" rather than "thermometer".

```
Wire.begin();
pinMode(RPIN,OUTPUT);
```

We now switch the RPIN (4 in our example) to the OUTPUT mode. This means the digital pin will be writing data to the relay.

```
}

void loop(void) {

    float avResistance;
    float resistance;
    int combinedReadings[READINGS];
    byte val0;
    byte val1;

    // Our temperature variables
    float kelvin;
    float fahrenheit;
    float celsius;
    int channelReading;
    float analogReadingArduino;

    // Our cURL variables
    CURL *curlInst;
    CURLcode result;
```

To the original thermometer code, we now add two cURL related variables. The `curlInst` variable will be where we initialize our cURL instance. The second variable—`result`—will be used to store the output of the cURL request.

```
/******  
  
    ADC mappings  
  
    Pin Address  
  
    0  0xDC  
    1  0x9C  
    2  0xCC  
    3  0x8C  
    4  0xAC  
    5  0xEC  
    6  0xBC  
    7  0xFC  
*****/  
  
    // 0xFC is our analog 7 pin  
    Wire.beginTransaction(8);  
    Wire.write(byte(0xFC));  
    Wire.endTransmission();
```

As we mentioned earlier in this chapter, we have updated the analog pin to 7. The code for this is `0xFC`.

```
/* Grab the two bytes returned from the  
   analog 7 pin, combine them  
   and write the value to the  
   combinedReadings array  
*/  
  
for(int r=0; r<READINGS; r++){  
    Wire.requestFrom(8,2);  
    val0 = Wire.read();  
    val1 = Wire.read();  
    channelReading = int(val0)*16 + int(val1>>4);  
    analogReadingArduino = channelReading * 1023 /4095;  
    combinedReadings[r] = analogReadingArduino;  
    delay(100);  
}
```

```
// Grab the average of our 7 readings
// in order to get a more accurate value
avResistance = 0;
for (int r=0; r<READINGS; r++) {
    avResistance += combinedReadings[r];
}
avResistance /= READINGS;

/* We can now calculate the resistance of
   the readings that have come back from analog 0
*/
avResistance = (1023 / avResistance) - 1;
avResistance = TENKRESISTOR / avResistance;
resistance = avResistance / THERMISTOR;

// Calculate the temperature in Kelvin
kelvin = log(resistance);
kelvin /= BETA;
kelvin += 1.0 / ROOMTEMPK;
kelvin = 1.0 / kelvin;
printf("\nTemperature in K ");
printf("%f \n",kelvin);

// Convert from Kelvin to Celsius
celsius = kelvin - 273.15;
printf("Temperature in C ");
printf("%f \n",celsius);

// Convert from Celsius to Fahrenheit
fahrenheit = (celsius * 1.8) + 32;
printf("Temperature in F ");
printf("%f \n",fahrenheit);
```

We are now going to add the code that switches the thermostat on and off depending on whether the temperature is higher or lower than our setpoint.

```
if(celsius > SETPOINT && running == false)
{
    printf("Switching fan on ");
    digitalWrite(RPIN,HIGH);
```

```
        running = true;
    }
    else
    {
        if(celsius < SETPOINT && running == true)
        {
            printf("Switching fan off ");
            digitalWrite(RPIN,LOW);
            running = false;
        }
    }
}
```

Our code here checks to see if the fan is off and the temperature has risen above the setpoint. If these conditions are met, then we set the `RPIN` (4) to `HIGH` and set the boolean flag `running` to `true`.

Setting the digital pin 4 to `HIGH` changes the switch in the relay and completes the circuit turning our fan on.

If, however, the fan is running and the temperature drops below the setpoint, then we set the digital pin to `LOW`; this switches the relay to the off position and breaks the circuit from the plug to the fan. After this, the `running` flag is set to `false`. The portion of our code that sets the relay on and off based upon the temperature is now complete.

We will now finish the modifications to our code by creating a URL with the temperature data we recorded stored in it. Add the following block of code:

```
// Call to the temperature database
curlInst = curl_easy_init();
if(curlInst) {

    char url[40];
    //The IP address below should be the IP address of your
    Raspberry Pi
    sprintf(url, "http://192.168.1.72/addtemperature?temperature=
%f&room=1", celsius);

    curl_easy_setopt(curlInst, CURLOPT_URL, url);

    result = curl_easy_perform(curlInst);

    //If our request fails output the errors.
    if(result != CURLE_OK)
        fprintf(stderr, "curl_easy_perform() failed: %s\n",
            curl_easy_strerror(result));

    curl_easy_cleanup(curlInst);
}
```

Here we initialize cURL and then create a new variable called `url` which will store the HTTP address we are going to call. Following this, we use the `sprintf` function to create a URL string containing the Celsius reading from the thermistor.

The `curl_easy_setopt` function is then responsible for telling `libcurl` how to behave. Here we are setting the option for the URL; this will be the value we stored in the `url` variable given previously. We then fire off the URL using the `curl_easy_perform` function. The result of this call is stored in the `result` variable.

Next, we check if there was an error in executing the URL and if the request failed, we output an error message. Finally, we run the `curl_easy_cleanup` function to close the connection.

```
    // Three second delay before taking our next
    // reading
    delay(3000);
}
```

This completes the modifications to the thermometer code needed to switch the relay on and off and write the temperature data in a URL format. We can now create a new `Makefile` to compile our new code.

From within Geany; create the new file and add the following:

```
Thermo: arduPi.o
    g++ -lrt -lpthread -lcurl thermostat.cpp arduPi.o -o thermostat
```

Once you have saved the `Makefile`, you can try running it from the Build menu. If you have any compilation errors, fix these and then try building again. Once complete, you can now test the code with your fan.

Testing our thermostat and fan

We have our hardware setup and the code ready. Now we can test the thermostat out and see it in action. First, we will attach the fan and then run the application generated by our previous `Makefile`.

Attaching the fan

Make sure that your Raspberry Pi is powered down and that the fan is not plugged into the wall. Using a wire stripper and cutters, cut one side of the cable connecting the plug to the fan body. Take the end of the cable attached to the plug and attach it to the **COM** point on the relay. Use a screwdriver to ensure that it is fastened correctly. Now, take the other portion of the cut cable that is attached to the fan body and attach this to the **NO** point. Once again, use a screwdriver to ensure it is fastened securely to the relay. Your connection should look as follows:

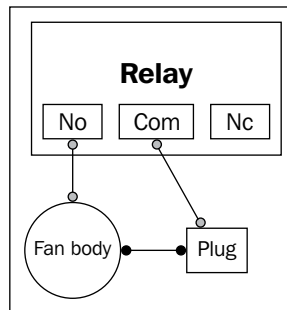

You can now power up your Raspberry Pi, relay, and fan.

Starting your thermostat application

From the command line, launch screen, create a new tab, and label this `Thermostat`. Then from within this screen session, start your application:

```
./thermostat
```

Your application will be launched in the screen session. When you log out of your Raspberry Pi or close your SSH session, it will continue to run in the background. You can reconnect to it by typing `screen -r` in the terminal window when logging back in.

Now that our application is running, you should see that when the temperature of the thermistor passes the setpoint the fan switches on. You can test this by warming up the thermistor if the room temperature is not greater than the setpoint. In order to test if it switches off correctly, try cooling down the thermistor.

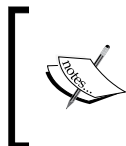

If using ice to cool down the thermistor avoid placing the ice directly near the circuitry to avoid accidents. Instead, use the ice to cool your hand down and then place this over the thermistor. Ensure your hand is dry before touching it.

If the fan switches off and on as the temperature changes, then you have successfully built your first thermometer.

Debugging problems

If the fan does not switch on there could be one of several problems. You can then try the following steps:

1. Check that the code compiled without any errors and started correctly.
2. If your application was not running in screen and you logged out of the shell session, then it probably shut down. Try launching the thermostat program in screen.
3. Make sure that you are applying enough of a change in temperature to the thermistor in order to exceed the setpoint.
4. If none of the above works, power down your Raspberry Pi and unplug the fan. Check that the fan's wires run to the correct points on the relay and are secured correctly. Completely power your Raspberry Pi back up, reconnect the fan, and then try rerunning the thermostat application.
5. If your relay needs an external power supply, check if this is plugged in and connected.

 Always remember to unplug the power when adjusting the connections to the relay to avoid an electrical shock.

Summary

In this chapter, we learned about relays and how they work. We modified our existing code to expand its functionality. This enabled it to switch the relay on and off based upon our temperature readings. We also set our program up ready to write the temperature data to a database. We launched this program in a screen session so that we can log out of our Raspberry Pi without terminating it.

Finally, we connected the fan and used the relay to switch it on and off. Now that you have a thermostat device, you can try out other projects with it. For example, you could use it to switch on a small heater when the temperature drops.

With our hardware and software complete, we will move onto our next project. This will involve creating a database that can store the values output by our application and then installing some tools to view the stored data via our web browser.

6

Temperature Storage – Setting up a Database to Store Your Results

In this chapter, we will cover setting up a database on your Raspberry Pi using **SQLite**. This SQL-based database will be used for storing the results from the temperature readings that we captured in the previous chapter. We will also look at **HyperText Structured Query Language (HTSQL)**, a language that allows you to query your database via HTTP requests.

Along with these technologies, we will set up an **Apache** web server running **Python** via **WSGI**—a server-side programming language that we can use to run SQL queries against our database.

Let's get started, our first step will be to install SQLite Version 3.x and set up our temperature database.

SQLite

SQLite Version 3.x is the latest version of the SQLite series of database technologies. Written in the C programming language, SQLite is a relational database management system that has continued to support more of the SQL standard as it has progressed through several versions.

This means that many of the features you may be familiar within SQL are available to use when creating an SQLite database.

SQLite has many uses, which include creating databases for embedding in applications such as web browsers or for creating lightweight databases for embedded systems running on hardware such as the Raspberry Pi. It is also practical for small projects that do not require a more complex and maintenance-heavy RDMS such as Oracle or MS SQL and for those looking for a free and easy solution for storing data.

You can read more about the technology and the latest features it supports on its website:

<http://www.sqlite.org/>

Installing SQLite Version 3.x

We will now walk through the process of installing SQLite on our Raspberry Pi. Either log in to your Raspberry Pi via SSH, or connect over the desktop and open LXTerminal. Once logged in, we are going to run `apt-get` to install SQLite3.

From the command line, type the following command:

```
sudo apt-get install sqlite3
```



If you run `sudo apt-get install sqlite`, this will only install SQLite Version 2.x. Version 2.x does not support some of the commands we will be using such as `ALTER TABLE`. So make sure you use `sqlite3` when using `apt-get`.

The terminal will show you feedback as it installs SQLite. Once complete, navigate to your home directory – if not already there – and then create a new directory within which we will work. Type the following commands into your terminal window:

```
cd /home/pi/  
mkdir database  
cd database
```

This database directory will be used to store our `temperature` database for testing and for demonstrating how to use SQLite. Once we set up our web server, we will copy the database to a directory where the Apache can access it.



If you are already proficient with Linux and SQLite or as you gain experience with this technology, you may wish to change the configuration of where your databases are stored and not keep it located with the website. For the purposes of this project and to get you up and running with the technology, we will keep the files in the same directory structure under the `www` folder; however, feel free to change this if you wish.

Creating a database

To load SQLite, you simply type the command line name `sqlite3` followed by the database name and the extension `.db`. If it does not exist, SQLite3 will create this database for you, for example, `mydatabase.db`.

For our project, we will name the database `temperature`. On the command line, type the following:

```
sqlite3 temperature.db
```

You will now be dropped into the SQLite3 shell. From the SQLite shell, we can type commands that will create tables in the database and assign columns to them within which we will store data. Before creating anything in our database, we should consider what tables and columns we are going to need.

For this project, we only need a simple database, and two tables should be enough to record the data we want to store. One table will be responsible for storing the temperature data and the other for recording the details of the room the Raspberry Pi is located in.

Let's look at the `temperature` table first.

A table to record our temperature

The `temperature` table will be responsible for storing the data written back from the Arduino shield. We will need the following columns:

- **Id:** This will be the unique ID for each temperature reading written to the database. With each new value added, it should auto increment, and should also be the Primary Key for our table.
- **Roomid:** The `roomid` will serve the purpose of linking the temperature reading to a table containing information about the room it was taken from. For example, in our project, we will store the name of the room here.

- **Temperaturec:** This column will be used to store our temperature reading in Celsius. This value will have been calculated by the Arduino shield and sent back ready to be inserted into the database.
- **Datetime:** We will calculate a time stamp for each reading when inserting data into the table. This can be useful when querying the database and trying to find out, for example, which time periods are coldest in a given room.

A table to record our rooms

The second table we will create will store the name of the room in it. This table can then be expanded in the future to include extra details about the room. To start with, though, we will only need two columns:

- **Id:** This will be a unique ID for the room and will be incremented with each room added. When we add data to the `temperature` table, we will insert this room ID. This way if we decide to rename the room, we only have to make an update to a single value in one table, rather than replace multiple instances, which would be the case if we had recorded the room name next to each temperature reading in the `temperature` table.
- **Roomname:** The second column we are adding is for storing the room name. Here we can store a value such as `bathroom` or `kitchen`.

Writing some SQL

Now that we have mapped out our two tables, we can create them using SQL. From the SQLite3 shell, enter the following SQL command:

```
CREATE TABLE roomdetails (id INTEGER PRIMARY KEY AUTOINCREMENT, room
VARCHAR (25) );
```

This command creates a new table called `roomdetails`, it adds an ID column that takes integer values, it is the primary key of the table and with each new value that is added, the ID is incremented by one. Next we will create the `temperature` table. Type the following SQL command into the SQLite3 shell:

```
CREATE TABLE temperature (id INTEGER PRIMARY KEY AUTOINCREMENT, roomid
INTEGER, FOREIGN KEY(roomid) REFERENCES roomdetails(id));
```

The preceding command has now created our second table called `temperature`. This table will be used to store each of our temperature readings. The SQL command has created two columns, the first being the ID that like the `roomdetails` table is an integer and auto incremented.

The second column created will be used to store the room IDs. This column references `roomdetails` and creates a foreign key link to it. Now that we have the `temperature` table, we can add the other two columns to it, those being `temperaturec` and `datetime`.

For this task, we can use the SQL command `ALTER TABLE` in order to add a new column to an existing database.

From within the SQLite3 shell, enter the following SQL command:

```
ALTER TABLE temperature ADD COLUMN temperaturec FLOAT(8);
```

We have now updated our `temperature` table and added the column for storing the temperature readings from the sensor on the Arduino shield. This column accepts numeric float values eight characters long, which means we can store decimal numbers such as 52.3, 48.4, and so on.

Finally, let's add the date stamp column to our database so we can check when our temperature readings were stored. Using the shell, execute the following command:

```
ALTER TABLE temperature ADD COLUMN datetime DATETIME;
```

We have now added our final `datetime` column to the table, this column takes a date-formatted value in the following format `YYYY-MM-DD HH:MM:SS`.

Now we have our two tables in place, let's add a room to the `roomdetails` table. This could be the room that you have your Raspberry Pi thermostat running in. In the following example, we have used `Kitchen` as the value. From within the SQLite3 shell, execute the following command:

```
INSERT INTO roomdetails (room) VALUES ('Kitchen');
```

Now you can check to see if our room is present by using:

```
SELECT * FROM roomdetails;
```

This command selects all values from the `roomdetails` table and displays them. If you added `Kitchen` as your room, you should see:

```
1|Kitchen
```

So we now have a room in our database with an ID of 1 that we can use when writing data back from the Arduino application.

In *Chapter 5, From Thermometer to Thermostat – Building upon Our First Project*, you may remember that we included the value 1 as the room ID parameter when executing Arduino code. Also you may remember that we included a reference to a URL called `addtemperature`. We will now set up a web server and create a script with this name that accepts that room ID parameter so that the Arduino shield can communicate with our new database. From the shell, type the following command to exit SQLite3:

```
.quit
```

Apache web server

The Apache web server was first developed in 1995. It sprung out of a project at the National Center for Super Computing Applications developed by Rob McCool called the **HTTP daemon (httpd)**, which provided a method for Linux servers to deliver content over the HTTP protocol.

After support for the HTTP daemon waned following Rob McCool's departure from NCSCA, several users of the daemon came together and combined their patches using httpd Version 1.3 as a base. This combination of patches into a single open source web server became known as Apache. Apache provided a free open source alternative to the other web servers on the market.

We will be using Apache Version 2.x to host web-based applications on our home network. These applications can then be used to perform tasks such as write data to a database or provide a web interface to the data generated by our temperature sensors.

Now we have briefly looked at Apache and why we are interested in using it. Let's get started with setting it up.

Setting up a basic web server

If you are not already in a shell session after exiting SQLite3, open up the terminal window. In the command line type the following.

```
sudo apt-get install apache2
```

This will install Apache Version 2.x via the `apt-get` tool. While installing, you will be prompted to continue, a message will be displayed noting how much disk space will be used on your SD card by the installation process:

```
After this operation, 4,990 kB of additional disk space will be used.
```

```
Do you want to continue [Y/n]?
```

You can type `Y` to continue. The installation process will complete and you will then see a message similar to that shown in the following screenshot:

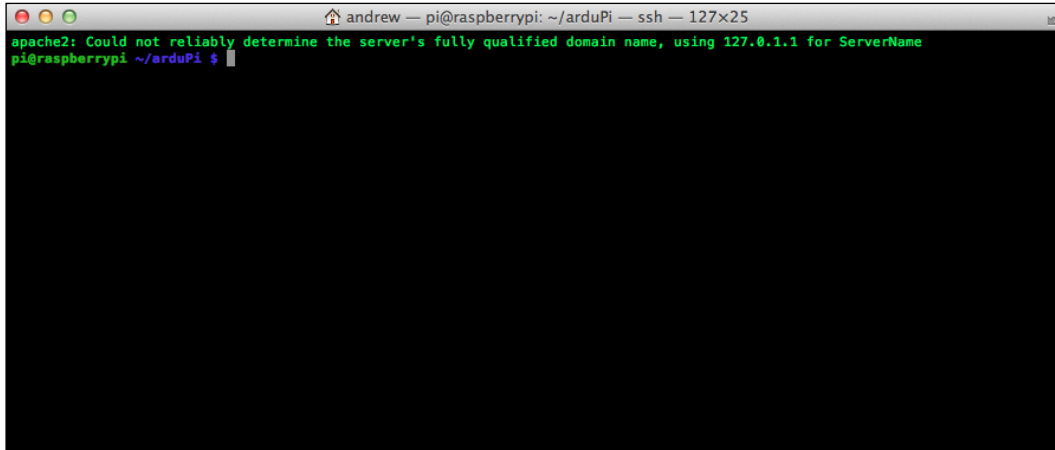
A screenshot of a terminal window. The title bar shows 'andrew — pi@raspberrypi: ~/arduPi — ssh — 127x25'. The terminal output shows a green error message: 'apache2: Could not reliably determine the server's fully qualified domain name, using 127.0.1.1 for ServerName'. Below the message is the prompt 'pi@raspberrypi ~/arduPi \$' with a cursor.

This message informs us that our web server has been assigned its local loopback IP address `127.0.1.1` as its server name. If you wish, you can access Apache from the Midori browser on your Raspberry Pi via `http://127.0.0.1/` or `http://localhost/`.

In turn, we can access the web server on our home network using the IP address assigned to our Raspberry Pi by our router.

 You can always check your Raspberry Pi's IP address using the `ip addr show` command and looking for the value located next to `inet`

There are several commands that are useful for starting, stopping, and restarting your web server. These are:

- **apachectl start:** This command starts the Apache web server. If the server is already running you will be presented with an error message.
- **apachectl stop:** As the command suggests, running this stops the web server.
- **apachectl restart:** This command will restart an existing running web server and if none exists, will start a new one.

- **apachectl graceful:** Like the restart command, graceful also restarts an existing server and starts a new one if none exists. However, unlike the restart command, currently existing connections to the web server are not aborted.
- **apachectl graceful-stop:** This command also stops the web server, but like the graceful command, does not abort existing connections.



The Apache web server is run under the `www-data` user. You may need to add a `www-data` group and the `www-data` user to this group in order for Apache to start. You can do this by using the commands, `sudo addgroup www-data` and `sudo usermod -a -G www-data www-data`.

Further commands and help can be found in the manual (man page) for Apache Version 2.x. To access this document, type in the terminal the following command:

```
man apache2
```

To exit, you can press `Q`. Now that we have Apache Version 2.x installed and know how to access the manual, let's try restarting the server.



You will need to prefix your commands with `sudo` in order to perform tasks such as restarting the Apache server. If you do not wish to do this, you can switch user to root using `sudo su root`.

In the command line, type the following command:

```
sudo apachectl restart
```

You should now see the Apache server restarting. Once complete we can check that it is indeed running by seeing if the test `index.html` page located in `/var/www` is available via our browser.

Using your web browser, navigate to either the IP address assigned to your Raspberry Pi by your router, for example `http://192.168.1.122`, or navigate from the browser on your Raspberry Pi (for example, Midori) to `http://localhost/`.

You should now see in your browser a web page similar to that in the following screenshot:

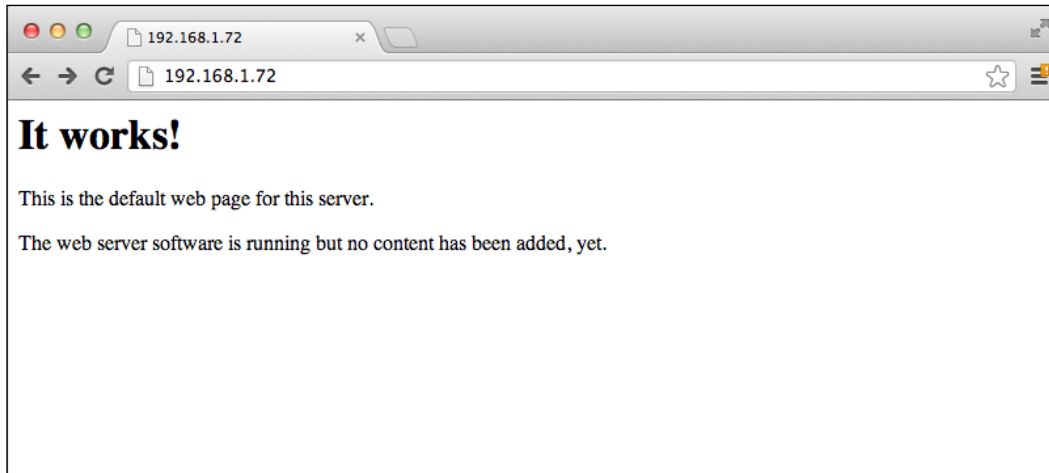

Congratulations! You have successfully set up a web server capable of serving HTML and other content on your home network.

For our home automation projects however, we would also like to be able to do more than serve static content such as the `index.html` page packaged with Apache.

In order to do this, we will need to be able to run server-side code such as Python. Python will allow us to not only serve up static content, but also allow us to connect to our database to read and write data from it.

To gain this functionality, we will need to expand the capabilities of Apache by including WSGI.

WSGI

Web Server Gateway Interface (WSGI) is a Python standard used by web servers to allow communication between Python web applications and themselves.

For the Apache web server that we installed, its functionality can be expanded to serve Python applications by including a module that provides support for WSGI.

With this installed, we can then build server-side applications accessible via a web browser that can write data to our SQLite database.

Setting up WSGI

The copy of Apache installed on the Raspberry Pi does not include WSGI by default. Therefore, we will need to use `apt-get` to install the module onto Raspbian. Open up the terminal and run the following command:

```
sudo apt-get install libapache2-mod-wsgi
```

Once the process has completed, you will now have the necessary code on your machine to support Python web applications.

However, before we can serve these applications, Apache will need to be configured to let it know which directory the files are located in, where the WSGI module is located, and which URL to serve them on. From the command line, navigate to the following directory:

```
cd /var/www/
```

Within this directory, add a new folder with the following name:

```
sudo mkdir wsgi-scripts
```

This is the directory where we will store our Python WSGI scripts. Using the command line or whichever tool you are using to edit text files, navigate to the following directory:

```
/etc/apache2/sites-available
```

Open the file called `default`.

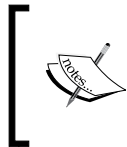

When working from the Raspbian desktop, you can open a terminal window and launch Leafpad with the command: `sudo leafpad`. This will allow you to edit the files located in `/etc/apache2` and `/var/www/`.

This file contains the settings for our website and is where we will need to add the additional configuration for allowing Python applications to be run on it. Navigate to the bottom of the file and add the following line:

```
WSGIScriptAlias /addtemperature /var/www/wsgi-scripts/addtemperature.  
wsgi
```

This tells Apache to take a Python script called `addtemperature.wsgi`, located in the `/var/www/wsgi-scripts/` directory you just created, and make it available via the browser with the URL `/addtemperature`; for example, `http://192.168.1.122/addtemperature`. After this, add the next block of configuration code below the `WGIScriptAlias`:

```
<Directory /var/www/wsgi-scripts>
    Order allow,deny
    Allow from all
</Directory>
```

This defines a directory `/var/www/wsgi-scripts` and tells Apache to accept traffic to it. This tag is responsible for defining configuration options for the directory listed and subdirectories below it. Then save and exit your text editor and navigate back up to the `apache2` directory:

```
cd /etc/apache2
```

In this directory we need a file called `httpd.conf`. This file provides additional user configuration for Apache. If this file does not exist, use your text editor to create it, otherwise open the existing one.

We need to add a single line of configuration to this that tells Apache where it can find the WSGI module that is needed to load our site configuration that we created previously. If we do not add this to the `httpd.conf` file, then Apache will not know what to do with the configuration we added to the default file and will throw an error and not start.

So with the `httpd.conf` file open, if the file already existed, look for other references to modules in the file these will take the following format:

```
LoadModule <module_name> modules/<module_reference>.so
```

If you created a new `httpd.conf` file, or no `LoadModule` references already exist, then you can paste the following configuration into the empty file, otherwise add this under the existing `LoadModule` references:

```
LoadModule wsgi_module modules/mod_wsgi.so
```

Save the file and exit your text editor. Now restart Apache using the restart command.

```
sudo apachectl restart
```

Finally, before we write our web application to add temperature recordings to our database, let's copy it over to the `www` directory. Using the command line, navigate to the web directory using the code:

```
cd /var/www
```

From within this directory, create a new folder to store your database in and change directory into it:

```
sudo mkdir database
cd database
```

Let's take a copy of the database we created earlier and used to test SQLite, and copy it to our new database directory:

```
cp /home/pi/database/temperature.db .
```

We now have Apache set up with a directory to add our new Python scripts to and a database located locally which we can write data to.

When we added our configuration to the default file for Apache, we included a reference to a script called `addtemperature.wsgi`.

Our next step is to create this script.

Creating a Python application to write to our database

In order to write data to our SQLite database, we will need a server-side application capable of connecting to the database and running SQL queries against it. For this task, we are going to use the Python programming language and use the WSGI module we configured to serve this application. Navigate to the directory you created in the preceding section to store WSGI scripts in by using the following command:

```
cd /var/www/wsgi-scripts
```

This will be where we will create our Python script capable of running SQL queries. Using your text editor, create a new file called `addtemperature.wsgi`.

We are now going to add our Python code to this file.



In the Python language, indentation and white spaces are important. When typing in the code or copying and pasting, make sure that you follow the indentation format in the examples.

With `addtemperature.wsgi` open, add the following lines to the top of your script:

```
import sqlite3
from cgi import escape, parse_qs
```

These two lines tell our script to include a library that supports SQLite3 and to also import some useful tools from the CGI library that we can use to escape user input and parse incoming query strings received by our script.

Once you have added them, let's add a function that is capable of processing the data sent to the script and then use that data to populate our sqlite3 database.

Copy the following block of code into your file below the previous two lines you added:

```
def application(environ, start_response):

    connection = None
    my_response = ""
    params = parse_qs(environ['QUERY_STRING'])
    room = escape(params.get('room', [''])[0])
    temperature = escape(params.get('temperature', [''])[0])
```

The first line of our code defines a function called `application`. When a WSGI request comes in, Apache will look for the `application` function and then execute the code located within it. The function takes two default parameters, `environ` and `start_response`.

Following from the function declaration, we then define five variables that are used for storing data in our program.

The first of these is `connection`, this is where we will store the database connection object when we connect to the `sqlite3` database.

`my_response` is an empty string which we will assign our response message to and display in the browser.

The `params` variable is used to capture the values passed to the script in the URL query string and makes them available to the Python function for use. You may notice here that the `parse_qs` was included from the CGI library at the top of our script.

The `room` and `temperature` variables use values from the `params` variable we created previously. The escape function is responsible for providing some sanitizing on the user input. Since only our Raspberry Pi on the home network will be using this script, there isn't a big risk of SQL injection attacks; however, it is good practice to code with this in mind.

These two variables take the values of specific parts of the query string, which in this case have the same name as the variable. We can then use these two variables in the SQL query we are going to write.

Next up, we will write the code that creates a query and uses the value of the `room` and `temperature` variables.

After the variable declarations, paste the following code:

```
my_query = 'INSERT INTO temperature(roomid,temperaturef,datetime)
VALUES (%s,%s,CURRENT_TIMESTAMP);' % (room,temperature)
try:
    connection = sqlite3.connect('/var/www/database/temperature.db'
    ,isolation_level=None)
    cursor = connection.cursor()
    cursor.execute(my_query)
    query_results = cursor.fetchone()
    my_response = 'Inserted %s for room %s' % (temperature, room)
except sqlite3.Error, e:
    my_response = "There is an error %s:" % (e)
finally:
    connection.close()
```

In the Python script you added, we start by creating a variable called `my_query` and into this variable, we add our SQL query string.

The query string inserts into the `temperature` table in our database the values from our `room` variable and `temperature` variable.

Following from this, we then use our `try except` block to create a connection to our database. The database connection is stored in the `connection` variable if successful.

You will notice that we have included the path to the `temperature.db` file when creating the connection object. You should make sure that this path matches your own.

Once we have a connection to the database, we can run our query against it; we achieve this by creating a cursor object and then executing the SQL stored in the `my_query` variable.

The results from the query are then stored in the `query_results` variable. While we do not use this at the moment, you can expand your script in the future to use this variable in the values returned to the browser. For example, if your query used a `SELECT` statement to return a value, it would be stored here.

The `my_response` variable that we declared earlier is now assigned a string containing the message that the values we sent to the script were inserted into the database. Finally, we close the connection to the database.

The `except` statement will return an error to the browser if a connection could not be established. This could be because the path you declared in the connection variable is wrong, or because your script does not have permission to open the database.



If you have problems with connecting to the `temperature.db` file from your WSGI script, these may be permissions related.

The database directory needs to be owned by the user: `www-data`. Try setting the directory ownership to the `www-data` user with the following command:

```
chown -R www-data /var/www
```

You can also try using the `chmod` command and changing the permissions on the file. While we would not normally recommend using this setting for a database file in general, you can try the following command to see if it fixes the error:

```
chmod 777 temperature.db
```

If this turns out to be the case, try changing the files read/write settings to something more secure that works.

You can read more about `chmod` on its man page by typing `man chmod`.

Now we have added data to our database and created some text information to return to the browser, we need to wrap up the script by sending a response back.

Below the lines you added previously, paste in the following code

```
status = '200 OK'
response_headers = [('Content-Type', 'text/plain'),
                    ('Content-Length', str(len(my_response)))]
start_response(status, response_headers)

return [my_response]
```

This final block of code returns a successful HTTP response with our text string located in it. This response is then interpreted by our web browser, and the string is displayed on the screen.

So we have reached the end of our Python script and while it is pretty simple, it demonstrates what is possible.

Save this script and we can now test it. Using your browser, go to `http://<your Raspberry Pi's IP address> /addtemperature?temperature=85&room=1`. For example, `http://192.168.1.122/addtemperature?temperature=85&room=1`.

If the request is run successfully, you should see **Inserted 85 for room 1** in your browser:

[ If you have problems with your script, you can check the Apache error logs at `/var/log/apache2/error.log`.]

Congratulations! You have written your first WSGI Python script for inserting data into the temperature database.

Conclusion

Of course, the script is fairly simple and does not do any validation on the data we pass in to see if it is in the correct format, nor does it use the `query_results` variable. You can expand upon this script to add more functionality to it once you are confident with how everything works.

Now we are writing data to our database, we need a method to view this data via the web and without having to log in to SQLite3 and write queries. The tool we are going to use for this is HTSQL.

HTSQL

Hyper Text Structured Query Language (HTSQL) is a technology that allows us to write queries on the fly for our database and execute them via a URL.

Developed by Clark Evans and Kirill Simonov of Prometheus Research, HTSQL is built upon the Python programming language and provides a HTTP-based query language that is translated into SQL. This allows complex queries to be written via the web browser, and queries to be embedded in client-side AJAX code without the need for writing server-side applications.

Rather than having to learn SQL and a server-side programming language such as Java, a database with an HTSQL server running on it can be accessed via JavaScript or a web browser such as Midori.

The benefit of using this technology is that it cuts down on the amount of server-side code such as Python we have to write and also provides us with a simpler syntax than SQL for querying a database.

You may remember we wrote the following SQL query for returning the values in our `roomdetails` table:

```
SELECT * FROM roomdetails;
```

In order to execute this, we had to be connected to our database via the SQLite3 shell, or we would have to write a Python application with the query in and access it via WSGI.

To access the same data via HTSQL, we would simply use `/roomdetails` in the URL bar of our browser, after the URL of our Raspberry Pi, for example, `http://localhost:8080/roomdetails`

An HTSQL server is very simple to set up on our Raspberry Pi, so let us get started by installing the necessary packages.

Download HTSQL

We are now going to install HTSQL; however, first we will need to install Python-pip. Pip is a Python based package management system that we will be using to install HTSQL.

```
sudo apt-get install python-pip
```

A message will be displayed informing you that the installation will take 14.5 MB of disk space. You can select *Y* and press *Enter* to continue with the installation process. Once installation is complete, we can use pip to install HTSQL. Type the following in the command line:

```
sudo pip install HTSQL
```

The HTSQL installation process will kick off and once complete, we can check that it was successful. In the command line type:

```
htsql-ctl version
```

You should see the terminal window text similar to that in the following screenshot:

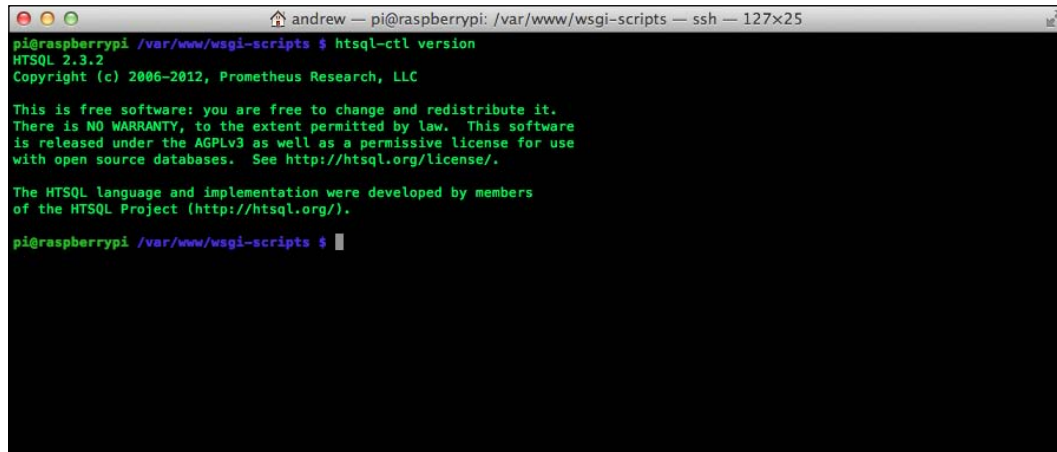

```
pi@raspberrypi /var/www/wsgi-scripts $ htsql-ctl version
HTSQL 2.3.2
Copyright (c) 2006-2012, Prometheus Research, LLC

This is free software: you are free to change and redistribute it.
There is NO WARRANTY, to the extent permitted by law. This software
is released under the AGPLv3 as well as a permissive license for use
with open source databases. See http://htsql.org/license/.

The HTSQL language and implementation were developed by members
of the HTSQL Project (http://htsql.org/).

pi@raspberrypi /var/www/wsgi-scripts $
```

The version number in this example, 2.3.2, will be whatever version you downloaded, which in the case of pip will be the latest.

Configuring HTSQL

The next step is to configure HTSQL and to point it to our database and then set up a server to allow us to query the database via our web browser.

We can test our connection to the temperature database we created as follows:

```
htsql-ctl shell sqlite:path/temperature.db
```

This creates a shell similar to the SQLite3 one on the database we created. In the preceding example, SQLite is the database type and the path follows this, completed by the database file name.

Once you can log in to the database via the HTSQL shell, then you can proceed with running a server.

Quit the HTSQL shell and then from the command line, create a HTSQL server as follows:

```
htsql-ctl server 'sqlite:path/temperature.db'
```

As with the preceding shell connection, the path should be replaced with the path to the database that we added to the folder `/var/www/database` or if you decided to use another directory, use that one instead.

Once the server has started, you will see the following message on the command line:

Starting an HTSQL server on raspberrypi:8080 over ../database/temperature.db

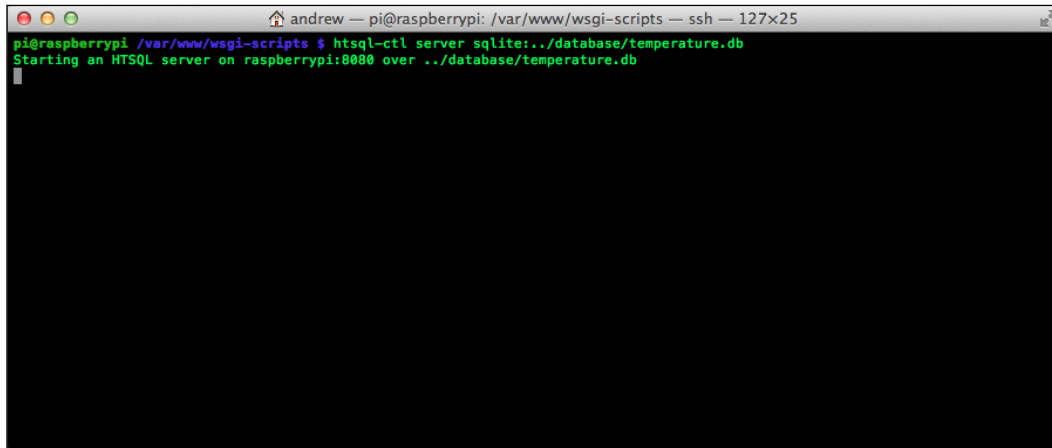

```
andrew — pi@raspberrypi: /var/www/wsgi-scripts — ssh — 127x25
pi@raspberrypi /var/www/wsgi-scripts $ htsql-ctl server sqlite:../database/temperature.db
Starting an HTSQL server on raspberrypi:8080 over ../database/temperature.db
```

We can now check that HTSQL is running as expected. Load up your web browser either on the Raspberry Pi or remotely, and in the URL bar, type: `http://<ip of raspberrypi>:8080`. You should now see the following message:

Welcome to HTSQL!

Please enter a query in the address bar.

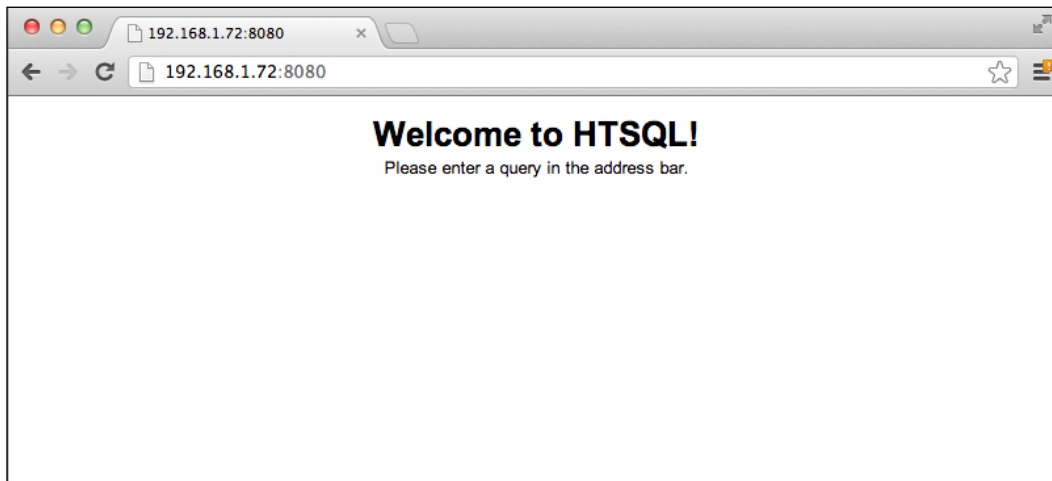

You can then display the `room` table we created by typing
`http://<ip of raspberry pi>:8080/roomdetails`

The database is now viewable via the web browser and the data can be seen in the temperature table as it gets added.

In order to query the data, we can use the `/roomdetails{id}` syntax:

You can place column IDs from your database between the braces separated by commas and only these columns will be returned when you execute the query:

```
/roomdetails?id='1'
```

Placing a question mark after the table name or the braces allows us to provide conditional statements, such as, show all of the data located in all of the columns where the ID is equal to one. In the case of our database, this should return a single result, and all of the column values for that result.

HTSQL has an expansive syntax and allows you to write complex queries for returning data in a variety of formats, including JSON, XML, CSV, text, and YAML.

You can read more about these at the HTSQL website and get a better idea of other methods of querying the data in your temperature database:

<http://www.htsql.org>

Testing our Arduino shield with our database

Now that we have a way to write data to our database, we can now start taking and storing readings from our Raspberry Pi to Arduino hardware.

From the command line, run the `thermostat` application located in the `arduPi` directory. Once this is running, the shield will start to take temperature readings.

In turn, the Arduino code references the Python script we have just written and will start to send the temperature data to it for the room you associated with the ID 1.



Make sure that both Apache and the HTSQL server are running!

The Python script will then generate a connection to the SQLite database and execute the query inserting the temperature data, timestamp, and the room ID.

We can test that our data has made its way through the system by querying the temperature database via HTSQL. If for example, we wanted to see the room, temperature, and time stamp, we could use the `http://<ip of raspberry pi>:8080/temperature{room,temperaturec,datetime}?roomid='1'` query.

You should now see an HTML table listing the room data, temperature, and time stamp. You have now successfully set up your Raspberry Pi to store data from the Arduino shield and made it accessible to other machines on your home network.

Summary

We have now demonstrated a simple method for writing data to a database and to then be able to read it via our web browser.

This combination of technologies opens itself up to all sorts of interesting possibilities. We could expand the SQLite3 database to hold more information about each of the rooms we plan to store data on. We could expand our Python program to check that the data being written back to it is in the format we expect.

HTSQL opens up a variety of ways for writing interesting queries that we can use in our web browser to check our temperature readings, and one of the benefits is we can save these queries as bookmarks in our browser and use them whenever we need.

Hopefully this chapter has provided you with an interest in learning more about Python, HTSQL, and SQLite so that you can expand your home thermostat project further.

7

Curtain Automation – Open and Close the Curtains Based on the Ambient Light

In this chapter, we will be looking at how to use a photoresistor and a motor shield in conjunction with your Raspberry Pi. Once these are combined into a single device, it can be used to open and close blinds or curtains.

In previous chapter, we used temperature to change a relay's settings and in this chapter, we will use the same concepts, however, we will use a photoresistor to turn a motor on and off.

What you will need for this chapter:

- Raspberry Pi
- Raspberry Pi to Arduino bridge shield
- Breadboard
- Wires
- 10 K resistor
- Photoresistor
- Arduino Motor Shield
- 9 V battery and battery connector
- Flat-head screwdriver
- A flashlight
- 9 V DC motor and an optional 12 V DC motor
- 12 V wall wart if you use a 12 V motor

Photoresistors

A photoresistor is similar to the thermistor in that the device's resistance changes as some ambient property of the room changes. With the thermistor, this was temperature and with the photoresistor, it is light.

The most common application of these that you see in everyday life is in street lamps, which switch on when it starts to get dark outside.

We can use a photoresistor as part of our circuit to tell when it is getting dark in a room and send this information back to the Raspberry Pi. The Raspberry Pi can then process this data and use it to control an electric motor.

Motor shield and motors

For this project, we have chosen the official Arduino Motor Shield. This is a device we can connect to our Raspberry Pi to Arduino shield and then use it to attach and drive DC motors. The specifications for the shield can be found on the following Arduino website:

<http://arduino.cc/en/Main/ArduinoMotorShieldR3>

The shield has an operating voltage of 5 V to 12 V and for our project we will connect a 9 V battery to the screw terminal power connectors. This will provide enough power to drive the single 9 V motor that we are going to connect to it.

 For testing purposes, we will use a 9 V battery, however if you wish to install the motor shield based device, you may wish to consider attaching it to a wall wart or wiring it into the mains. A 9 V battery in constant use will not last very long and will not power a 12 V motor.

It is recommended that you disconnect the power pins on the shield if you connect devices that require more than 9 V. For this project, we start by using a 9 V motor; you can always upgrade to a 12 V once you have your application and circuit up and running.

Depending on the type of blinds you have, using a motor in the 9 V to 12 V range should provide enough torque.

Setting up the photoresistor

We are going to start by wiring up our photoresistor and testing it with some software. Once we have tested it, we can then hook it up to the motor shield and use the values it returns to turn the motor on and off.

Wiring up the components

Our first task is to set up our circuit. This process is very similar to when you created the thermistor circuit in *Chapter 3, Our First Project—A Basic Thermometer*.

You'll need your resistor, photoresistor, three wires (black, red, and yellow are used in the explanation), and the breadboard.

1. Take the red wire and connect it from the 5 V pin on the shield to the supply voltage on the breadboard.
2. Next take the black wire and connect it from the ground pin on the Raspberry Pi to the Arduino bridge shield to the ground on the breadboard.
3. As we did with the thermistor before, we will now connect a resistor to the breadboard. Connect one pin of your resistor to the supply voltage strip that your red wire is connected to and then connect the other end to a terminal strip.
4. We can now connect our photoresistor. Insert one leg of the photoresistor into the ground on the bus strip and place the second leg into the same row as you placed the resistor.
5. Finally connect one end of your yellow wire from the analog 7 (A7) on your shield to the terminal strip you selected.

Your completed layout should look similar to the following image:

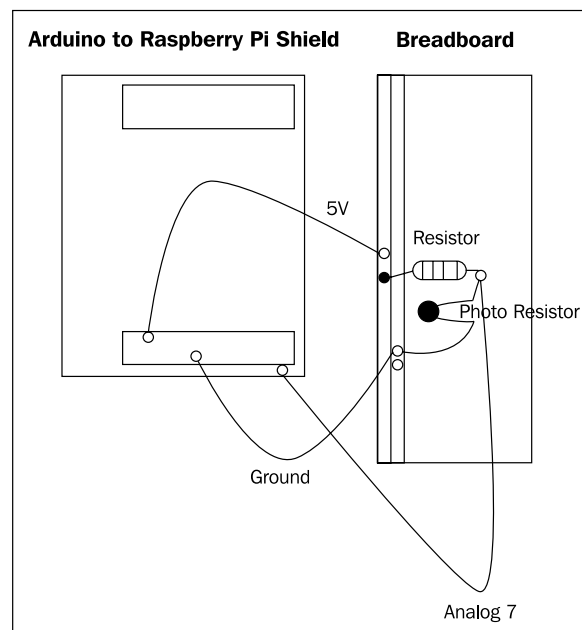

Now that we have the hardware in place, we can write an application to test our setup.

Testing the photoresistor with software

As with our earlier programs, we will use the arduPi template to create our test code. Open up Geany and create a new file. Add the following code to the file:

```
//Include ArduPi library
#include "arduPi.h"
//Include the Math library
#include <math.h>

//Needed for Serial communication
SerialPi Serial;

//Needed for accessing GPIO (pinMode, digitalWrite, digitalRead, I2C
functions)
WirePi Wire;

//Needed for SPI
SPIPi SPI;

#define TH 690
```

Here we have the standard template header, but we have also added a new constant called TH. This will represent the **threshold**. Like the **setpoint** constant we declared for the thermostat, the threshold is used to calculate whether to perform an operation based upon the room getting lighter or darker.

```
/* *****
 * IF YOUR ARDUINO CODE HAS OTHER FUNCTIONS APART FROM *
 * setup() AND loop() YOU MUST DECLARE THEM HERE *
 * ***** */

/* *****
 * YOUR ARDUINO CODE HERE *
 * ***** */

int main (){
    setup();
```

```
        while(1){
            loop();
        }
        return (0);
    }

void setup(void) {
    Wire.begin();
}

void loop(void) {

    byte val0;
    byte val1;

    int channelReading;
    float analogReadingArduino;

    /*****

    ADC mappings

    Pin Address

    0      0xDC
    1      0x9C
    2      0xCC
    3      0x8C
    4      0xAC
    5      0xEC
    6      0xBC
    7      0xFC
    *****/

    // 0xFC is our analog 7 pin
    Wire.beginTransaction(8);
    Wire.write(byte(0xFC));
    Wire.endTransmission();

    Wire.requestFrom(8,2);
    val0 = Wire.read();
    val1 = Wire.read();
    channelReading = int(val0)*16 + int(val1>>4);
    analogReadingArduino = channelReading * 1023 /4095;
```

The preceding code will be familiar to you from the thermostat project. Here we are setting up analog pin 7 so we can read the values returned by the photoresistor. Next, let's add some code that displays a message if the photoresistor is recording more light or less:

```
    if(analogReadingArduino > TH ){
        printf("Getting lighter\n");
    }
    else
    {
        printf("Getting darker\n");
    }

    delay(3000);
}
```

As you can see in the `if` statement, we check if the light is greater than the threshold value and if it is, then the program displays the message **Getting lighter**. Otherwise, we display the message **Getting darker**.

Save the file as `LightSensor.cpp` and then create the following Makefile:

```
Photo: arduPi.o
g++ -lrt -lpthread LightSensor.cpp arduPi.o -o lightsensor
```

Once the Makefile is complete save the file, run the make from the build menu and then return to the terminal window. From the command line, we can now test the code by running:

```
./lightsensor
```

Now that the application is running, we can try out our photoresistor. Depending on the ambient light in the room you will see the message **Getting lighter** or **Getting darker**

If you see the **Getting darker** message, try shining your flashlight on the sensor, once the threshold is passed, the message will change to **Getting lighter**.

If however, you see the message **Getting lighter**, you can try placing a finger over the sensor and once the threshold is passed, the message will change to **Getting darker**.

Debug

Experiment with the photoresistor; if you have any problems with the sensor not working, try the following steps:

- Check if the components are connected securely on the breadboard and shield
- Try changing the threshold in the application to ensure that you are providing enough variance between the darkness and light being applied to the photoresistor

Setting up the motor shield

The first part of the circuit is complete; we have a device that can record the change in light and send this back to our application via an analog pin.

We now need to connect our photoresistor to the motor shield. Once these are combined, we will then have a device that can be used to control curtains or blinds.

Let's start by setting up our hardware.

Wiring up the components

Unlike previous steps, we will be making some small modifications to an Arduino shield. Our motor shield uses pins 11 through 13; however, the Raspberry Pi already has these pins set aside for SPI so we will need to disable some of the current pins on the motor shield. You will also need to use your flat-head screwdriver for some of these steps:

1. Unplug the red, black, and yellow wires connecting your breadboard to the Raspberry Pi to Arduino shield.
2. Bend the metal legs out on digital pins 4, 5, 6, 11, 12, and 13. You do not need to remove the legs, just ensure that they will not connect with the header on the bridge shield.
3. You can connect the motor shield to the Raspberry Pi to Arduino shield. We will now run some jumper wires to connect digital pins 11, 12, and 13 on the motor shield to digital pins 4, 5, and 6 on the Raspberry Pi to Arduino shield. Take your jumper wires and connect 11 to 4, 12 to 5, and 13 to 6.

4. Our two shields are now wired together. Next, connect two wires to the "A" terminal on your shield; you will need a small flat-head screwdriver in order to open and close the connection. Once these are in place, connect your battery connector to the ground and power connectors. Ensure that the black wire connects to negative and the red to positive.
5. Next connect your electric motor to the two wires connected to the "A" terminal. This completes the motor shield setup.
6. We can now reconnect our photoresistor. Connect the red wire into a 5 V power pin, the black back into a ground pin, and finally, the yellow wire to the analog 7 pin.
7. Our circuit is now complete. The following diagram should aid you in seeing what the final configuration looks like:

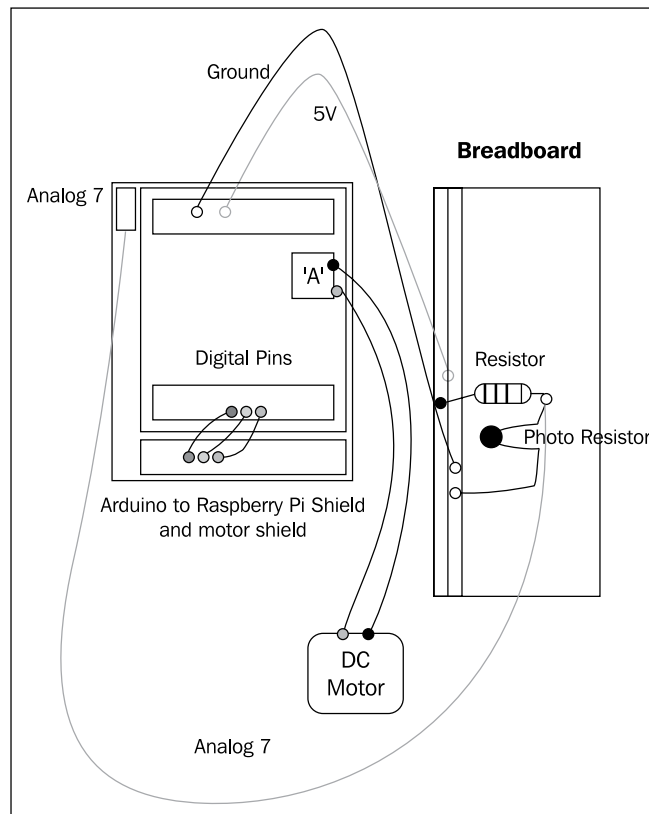

Curtain control application

We will now write an application that leverages the photoresistor and uses this to control the motor. There are a few concepts we will cover quickly before we write the application, in order to provide you with a better understanding of how our software works.

Pulse Width Modulation

Pulse Width Modulation (PWM) is a method that leverages the digital pins to create an analog result. If a digital pin is switched on, it has a value of 5 V and if switched off, it has a value of 0 V; PWM allows us to simulate a value between these two ends.

Using our software, we can create what is known as a **square wave**. This method involves switching a pin on and off to create a steady signal to the device connected to the digital pin. In our project, this is a DC motor, so varying the modulation, that is, changing the number of milliseconds that the pin is switched off versus on will result in a steady voltage being applied to the motor. This results in a change of speed in the DC motor.

In order to create PWM in our application, we will need to use "threads". We will look at these next.

Threads

You may have noticed that when running our `Makefile`, the compilation directives include a reference to `-lpthread`.

The `pthread` library allows us to create threaded applications. A thread is essentially a fork in the program that can continue to run while the application performs other tasks.

In the context of our program, this allows us to generate PWM outside of the `loop()` function that will run continuously until we tell it otherwise.

For example, in the `setup()` function, we can create a thread that generates PWM on pin 3 of the shield. In the `loop` function, we can perform other tasks and then "pause" the PWM thread, update the values used to generate PWM, and restart it. This new value will then be used in the PWM thread.

You will see this concept in action next in our curtain control application.

Writing our code

Let's take the light sensor code we wrote and expand it to start controlling the motor shield.

Start up Geany and create a new file called `CurtainControl.cpp`. Add the following code into this file:

```
//Include ArduPi library
#include "arduPi.h"

//Needed for Serial communication
SerialPi Serial;

//Needed for accesing GPIO (pinMode, digitalWrite, digitalRead, I2C
functions)
WirePi Wire;

#define TH 690
#define DIRECTION 5
#define PWMPIN 3
```

Here we have our standard template headers, as well as the threshold we defined in `LightSensor.cpp`. After this, we have added two new constants `DIRECTION` and `PWMPIN`.

The constant `DIRECTION` stores the pin on the motor shield that is used to define which way the motor is running, that is, clockwise or counterclockwise.

We use the `PWMPIN` constant to store the pin number of the pin on which we create a **square wave** (PWM) on. Now add the following code:

```
pthread_t pwmthread;
pthread_mutex_t pwwmutex = PTHREAD_MUTEX_INITIALIZER;
```

These declarations are used for the thread that we will generate when we create PWM on pin 3. The thread is stored under the variable name `pwmthread`. Next we add in two Boolean variables that act as flags:

```
boolean off_on;
boolean open_state;
```

One is used to store whether the motor is switched on or off and the second records the open/closed state of our blinds.

```

/*****
 * IF YOUR ARDUINO CODE HAS OTHER FUNCTIONS APART FROM *
 * setup() AND loop() YOU MUST DECLARE THEM HERE      *
 * *****/

/*****
 * YOUR ARDUINO CODE HERE *
 * *****/

void* pwm(void *args)
{
    while(1){

        if(off_on == true)
        {
            digitalWrite(3, HIGH);
            delayMicroseconds(100);
            digitalWrite(3, LOW);
            delayMicroseconds(1000 - 100);
        }
        else
        {
            digitalWrite(3, LOW);
        }
    }
    return NULL;
}

```

This function is concerned with the process of generating Pulse Width Modulation. The `while` loop runs indefinitely and the code within it is tasked with switching pin 3 between HIGH and LOW with a pause between each command to control speed.

There is a conditional statement that checks whether the motor should be switched on or off. If the variable is set to `false`, then this means the curtain is either fully open or shut, thus we switch the voltage applied to pin 3 to 0 (LOW).

We next need a function to control the motor's state. This function "pauses" the thread, updates the on/off state, and then "restarts" the thread.

```
void controlMotor(boolean state)
{
    pthread_mutex_lock( &pwmmutex );
    off_on=state;
    pthread_mutex_unlock( &pwmmutex );
}
```

This allows us to switch off the PWM at any point in our application, that in turn stops the motor.

```
int main(void)
{
    setup();
    while(1){
        loop();
        delay(100);
    }
    return 0;
}

void setup(){

    pthread_create(&(pwmthread), NULL, &pwm, NULL);
    pinMode(DIRECTION, OUTPUT);
    Wire.begin();
}
```

To the `setup()` function we have added two new statements. One creates the new PWM thread and the second sets the direction pin stored in the `DIRECTION` constant to `OUTPUT`.

```
void loop(){

    byte val0;
    byte val1;

    int channelReading;
    float analogReadingArduino;
```

```
/******  
  
ADC mappings  
  
Pin Address  
  
0      0xDC  
1      0x9C  
2      0xCC  
3      0x8C  
4      0xAC  
5      0xEC  
6      0xBC  
7      0xFC  
*****/  
  
// 0xFC is our analog 7 pin  
Wire.beginTransmission(8);  
Wire.write(byte(0xFC));  
Wire.endTransmission();  
  
//GET PHOTORESISTOR READING  
Wire.requestFrom(8,2);  
val0 = Wire.read();  
val1 = Wire.read();  
channelReading = int(val0)*16 + int(val1>>4);  
analogReadingArduino = channelReading * 1023 /4095;
```

Next we need to add some code that uses the data generated from the photoresistor on A7:

```
if(analogReadingArduino > TH && open_state == false){  
  
    controlMotor(true);  
    digitalWrite(DIRECTION, HIGH);  
    delay(5000);  
    open_state = true;  
    controlMotor(false);  
}  
else{  
    if(analogReadingArduino < TH && open_state == true){  
  
        controlMotor(true);  
        digitalWrite(DIRECTION, LOW);
```

```
        delay(5000);
        open_state = false;
        controlMotor(false);
    }
}
```

Here we have a conditional statement that checks the light readings against the TH (threshold) constant. If the curtains are shut and the light exceeds the threshold, then we do the following:

1. Call the `controlMotor()` function and pass the Boolean value of `true`.
2. Switch pin 5 to HIGH which sets the direction to clockwise.
3. Allow the motor to run for 5 seconds in order to open the curtain.
4. Call the `controlMotor()` function and pass in the Boolean value of `false` which turns the motor off.

Let's now look at the next part of the `if` statement.

Here we are checking if the reading from A7 is less than the threshold and the curtains are open. If this is true, it means the room is darkening and the blinds need to be closed:

1. Once again, we call the `controlMotor()` function and switch the motor on.
2. Next the direction is set to counterclockwise by writing LOW to the digital pin 5.
3. Next we apply a 5 second delay to allow the blinds to close fully.
4. Finally we switch the motor off.

This wraps up the application. We can now test it against our circuit. Create a `Makefile` for the curtain control application in Geany and add the following directives:

```
Curtain: arduPi.o
    g++ -lrt -lpthread CurtainControl.cpp arduPi.o -o curtaincontrol
```

Run the `make` command from the build menu and then return to the command line. Start the application up:

```
./curtaincontrol
```

Your curtain control application should now be running. If you try changing the light on the photoresistor, you will notice that the motor changes direction and eventually will stop.

Applying less and more light will cause the values returned by the photoresistor to pass the threshold and thus switch the motor on and off.

Debugging problems

If the application is not working, try the following steps to debug:

1. Recheck the steps involving rewiring the pins with jumper wires.
2. Check that all of the wires on the breadboard and the shield are connected firmly.
3. Ensure that you have enough power supplied to the motor shield. You can test it by using a 9 V battery hooked up to the power connectors.
4. Try changing the threshold value in the script to adjust for the ambient light in the room where your Raspberry Pi is located.

Connecting to your blinds/curtains

The final step is to connect your motor up to your blind/curtain hardware. This will largely depend on the product you are using. Remember as well that heavy curtain and blind hardware will require a higher torque motor, and you may wish to consider switching over to a 12 V motor at this point.



If you connect the 12 V power supply and motor, remember to disconnect the power pins on the motor shield.

Let's now look at the delay values we set in the `loop()` function.

Setting the timing

Our application has a delay of 5 seconds in the conditional statement that opens and closes the blinds. This was an arbitrary amount we set when creating our application. When you attach your motor to the blinds/curtains you will need to calculate the number of seconds required to open/shut the blinds. You can also adjust the values in the `pwm()` function to either speed up or slow down your motor.

Once you have set up the hardware, try experimenting with these values until you adjust the settings to your preference. For example, you may decide you never want the blinds fully closed or open and can adjust the setting so that the closed and open state is 75 percent of the open and closed state of the physical curtain.

Attaching the hardware

At this point, you will need to attach the DC motor to the curtain drawstring. The preferred method for doing this is via a pulley wheel.

A variety of grooved pulley wheels can be found online or in hardware and craft stores. Select one that fits the profile of your hardware.

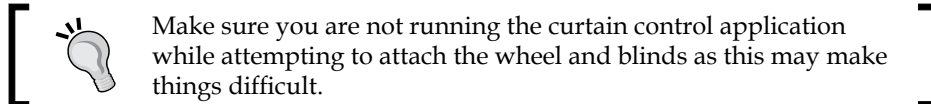

Attach the wheel to the axle on your DC motor; it should fit snugly so it does not fall off when the motor is switched on. Try testing your configuration out by launching the **curtaincontrol** program.

Once you are sure this works, you can now attach the drawstrings of your curtains or blinds to the wheel. This setup will largely depend on how the blinds are opened or closed. Commonly, there is a drawstring loop that can be pulled to open or close the blinds. This loop should be attached around the groove in the pulley wheel and fit tightly.

Now try changing the delay value in your application to 1 second. Next run the make again to recompile the application.

Our application will now run the open/close cycle for 1 second. Execute the application via the command line and note how far the curtain/blind will open/close in 1 second.

With this information, you should be able to estimate how many seconds are required to open and close your hardware. At this point, you can try refining the numbers until you reach the desired result.

Debugging problems

If the curtains aren't opening and shutting, there could be one of several problems here:

- Check that the pulley wheel is attached tightly to the axle.
- Make sure that the drawstring is attached to the pulley wheel and is tight enough to have grip when the motor starts.

- If the motor is having problems opening the blinds and you are using a 9 V motor, try upgrading to the 12 V motor.
- If the curtains are opening or shutting too quickly, adjust the delay as described earlier in the chapter.

You now have an application and circuit that can control your curtains or blinds based upon the ambient light in the room. Remember to check the tension of the drawstring as they may change over time and affect the accuracy of your open and close settings.

Summary

This chapter introduced us to several new concepts, including Pulse Width Modulation and using threads in our application. We also learned how to use a photoresistor and read the values from it.

Another important step we performed was modifying our motor shield. This provided an introduction to doctoring off-the-shelf Arduino shields to work with the Raspberry Pi.

Next we will wrap things up by reviewing what we have learned so far and looking at future projects that build upon the knowledge you have gained in building the various projects in this book.

8

Wrapping up

Throughout the previous chapters, we have looked at various tools and technologies in order to build devices to help automate our homes. The previous chapter should have given you a good introduction to the Raspberry Pi and Arduino technologies that you can now expand upon.

In this chapter, we will review what we have learned and then look at how you can grow your skills and start to design your own shields for the Raspberry Pi.

We will look at a Raspberry Pi prototyping shield and then following this, we will explore the GPIO pins of the Raspberry Pi so that you can interact with them via the shield. Next we will look at the `wiringPi` library and the Gertboard, both of which can be used for home automation projects. Following this, we suggest some *next step* projects that use the techniques you have learned in this book, and in some cases, build upon previous projects. Finally, we wrap up with an eye to the future.

In order to complete the prototype board task you will need:

- Raspberry Pi
- Adafruit Raspberry Pi prototyping shield
- An LED
- A soldering iron
- Protective glasses
- Solder

The Gertboard is available via Newark/Element14 at <http://www.newark.com/>.

Let's start by recapping on what we have covered so far.

A brief review of what we have learned

Chapter 1, An Introduction to the Raspberry Pi, Arduino, and Home Automation and *Chapter 2, Getting Started Part 1 – Setting up Your Raspberry Pi*, provided us with some background on the Raspberry Pi and on the Cooking Hacks shield. We saw that we can take a third-party shield and attach it to the Raspberry Pi. This provided us with the ability, via the Raspberry Pi's GPIO pins, to control devices hooked up to the shield.

Chapter 3, Getting Started Part 2 – Setting up Your Raspberry Pi to Arduino Bridge Shield and *Chapter 4, Our First Project – A Basic Thermometer*, covered connecting up devices via a breadboard and writing this data back to Raspberry Pi. We covered writing applications that leverage this data and using a third-party library to mimic many of the functions found in the Arduino programming language.

In *Chapter 5, From Thermometer to Thermostat – Building upon Our First Project*, we covered using the data that the Raspberry Pi had recorded to control another device, in this instance, a relay. We also looked at how to use our device to control mains electricity.

So far, these chapters covered the basics of interacting with our environment, controlling it, and tapping into our home's power supply.

Following this, in *Chapter 6, Temperature Storage – Setting up a Database to Store Your Results*, we set up some technologies to record our data and store it.

Chapter 7, Curtain Automation – Open and Close the Curtains Based on the Ambient Light, brought together some of our techniques from earlier chapters and using an Arduino Motor Shield, allowed us to control a DC motor.

You should see from the preceding part, we slowly built up a set of techniques that use similar ideas but are transferable to devices that have different applications at home.

We can now use these methods to build custom devices, which we will look at now.

Next steps

We have refreshed ourselves on the subjects covered so far. Let's look at the future projects that you can try.

First, we review the Prototyping Pi Plate. We will then look at the Gertboard and provide some background on it. Finally, we'll provide some ideas for future projects that can use either the Cooking Hacks shield, the Gertboard, or the Prototype shield.

Prototyping Pi Plate

The Raspberry Pi Prototyping Pi Plate shield is a kit provided by Adafruit industries and can be accessed from the following URL:

<http://learn.adafruit.com/adafruit-prototyping-pi-plate/overview>

It allows you to create a prototyping shield that connects to the GPIO pins on the Raspberry Pi. You will be familiar with this principle from the Cooking Hacks shield you used to build your previous projects. Unlike the Raspberry Pi to Arduino shield, this is a kit that needs to be soldered together.

By building this shield, you will provide yourself with a platform that you can use for custom projects.

The Prototyping Pi Plate consists of a single board, which is divided up between perfboard style and breadboard style pins.

Access to the Raspberry Pi GPIO pins is located around the edge of board where a number of screw terminals are fixed and also doubled up with standard pins located further in on the board.

The shield allows you to solder individual components to it, and also place a miniature breadboard between the screw terminals for prototyping.

Using an example from *Chapter 4, Our First Project – A Basic Thermometer*, we could solder our thermometer components directly to the prototype shield and thus have a compact device that uses a single shield.

A comprehensive guide to soldering the shield can be found at the following URL:

<http://learn.adafruit.com/adafruit-prototyping-pi-plate/solder-it>



Remember to wear protective eyewear when soldering to avoid risk of injury to your eyes. Also make sure to solder in a well-ventilated area.

Let's look at the GPIO pin arrangement and naming convention on the Raspberry Pi so you can cross-reference these with the Prototyping Pi Plate when you come to wire up your projects.

Wrapping up

This layout is based upon looking at the Raspberry Pi with the GPIO pins located at the top-right corner of the board. The pin arrangement is as follows:

1 - 3.3v	2 - 5v
3 - SDA0	4 - Not used
5 - SCL0	6 - Ground
7 - I07	8 - TxD
9 - Not used	10 - RxD
11 - I00	12 - I01
13 - I02	14 - Not used
15 - I03	16 - I04
17 - Not used	18 - I05
19 - MOSI	20 - Not used
21 - MISO	22 - I06
23 - SCLK	24 - CE0
25 - Not used	26 - CE1

The pins are located in two columns with each pin labeled with its role. For example, location 1 is the 3.3v pin.



You will notice that a number of these are labeled as *Not used*. These pins are currently not used and are set aside for future expansions of the Raspberry Pi's architecture.

With this information, we can write a custom code to interact with the pins or use other generic libraries that allow us to read and write data. The `wiringPi` library that we will now look at provides some software tools that we can use with our Raspberry Pi Plate.

The wiringPi library

The `wiringPi` library, written by Gordon Henderson, interacts with the Raspberry Pi in a similar fashion to the `arduPi` library. This provides an alternative to the software library you are currently using and can be explored for future projects.

You will find in `wiringPi` support for many of the Arduino functions you are familiar with, as well as custom support for PWM.

A comprehensive guide to the available functions is accessible on the `wiringPi` webpage at <https://projects.drogon.net/raspberry-pi/wiringpi/>.

The library is available on **github** and can be accessed via the following link:

```
https://github.com/WiringPi/WiringPi
```

The following steps will guide you through the installation process via the Raspbian command line.

Open up a terminal window and type the following command to install **git** version control software:

```
sudo apt-get install git-core
```



Git is a version control software application. It allows you to check out software code from github, which acts as a repository for various projects.

Once `git` is installed, you can then clone the library from github. In the terminal window, type the following command:

```
git clone git://git.drogon.net/wiringPi
```

This will create a copy of the `wiringPi` library on your machine.

You will find a `makefile` located in the `wiringPi` directory that will install the library on your system.

Once complete, there are a number of examples you can try out. One that may be of interest to you is `test2.c` in the example directory. This program simulates PWM, and if you connect a LED up to pin 2, you will see the LED slowly fade on and off.

The Prototyping Pi Plate and `wiringPi` library provide you with an interesting alternative to the Cooking Hacks shield. Let's now look at another technology that is available for the Raspberry Pi – the Gertboard.

The Gertboard

The **Gertboard** is a device that connects to the Raspberry Pi's GPIO pins like we have seen with the previous shields and provides the user with a variety of tools they can use to interact with electronic components.

The Gertboard was developed and named after Gert Van Loo.

Gert Van Loo, while working with Ebon Upton at Broadcom took, on the challenge of building a stripped down computer. Using a multimedia optimized processor, the BCM2835, he developed the prototype of the Raspberry Pi's alpha hardware.

Following from the success of the Raspberry Pi, Gert Van Loo worked upon a project that would expand what the Raspberry Pi could do further – the Gertboard. The Gertboard is a **printed circuit board (PCB)** with a combination of components that can be soldered together and connected to the Raspberry Pi, thus extending its capabilities via its GPIO pins.

Like its counterparts, it allows electronic components to be controlled via applications written on the Raspberry Pi.

While not an official product of the Raspberry Pi foundation, it has been given support by its members and distributed along side the Raspberry Pi through Newark/Element 14.

Much like the Raspberry Pi to Arduino shield, you will now be able to build embedded systems for your home that can perform a range of tasks from recording temperatures and controlling your thermostat, to using ambient light sensors that open and close your blinds.

Thanks to the combination of components that come as part of the kit, you will have sensors, LEDs, DACS, and motors available for home projects. This allows you to record analog data and convert it to digital, as well as move physical objects via motors and communicate error codes and states via LEDs.

Introduction to the Gertboard components

The first wave of Gertboards was shipped as a kit of separate components that needed soldering together. An updated kit, which comes pre-soldered, is being re-released at end of 2012.

The kit and pre-soldered board includes the following components:

- Buttons
- GPIO PCB board
- Ribbon cable
- LEDs (Light emitting diodes)
- ADCs (Analog-to-digital convertor)
- DACs (Digital to analog convertor)
- 48V Motor controller
- ATmega microcontroller

The following diagram shows the layout of the board, which we will now explore:

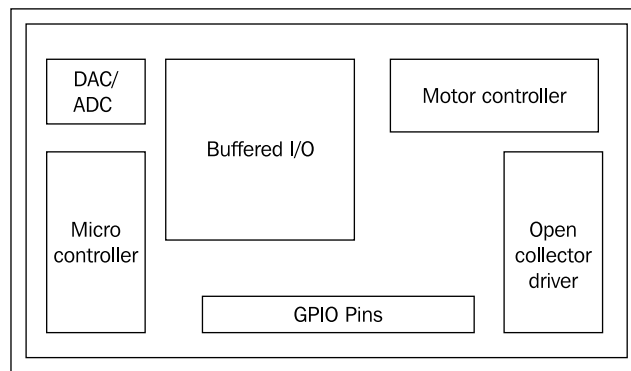

GPIO PCB expansion board

The GPIO expansion board is a pre-populated printed circuit board. This is the item that the components are soldered to and forms the foundation of the Gertboard. This board is what is connected to the Raspberry Pi via its GPIO pins.

GPIO Pins

The Gertboard, like the Raspberry Pi, comes equipped with its own set of GPIO pins. The ribbon cable provided in the Gertboard kit is used to hook the Raspberry Pi up to some of the GPIO pins in order to provide a physical communication medium between the two devices.

Motor controller

A motor controller can be used to control an electronic motor hooked up to it. Some examples of its functionality include switching a motor on and off, controlling its speed, and changing the torque and direction

The Gertboard's motor controller supports hooking up a DC (direct current) electric motor, which can be controlled via the motor controllers pins.

It also comes equipped with a fuse for current protection and internal temperature protection to help prevent overheating.

This removes the need to use a separate motor shield as we did in *Chapter 7, Curtain Automation – Open and Close the Curtains Based on the Ambient Light*.

Open collector driver

The open collector drivers are used to turn devices connected to the Gertboard on and off. This is especially useful when the device connected requires a higher voltage than available via the Gertboard.

One common application of the OC driver is to hook up devices for displaying visual data such as a **Vacuum Fluorescent Display (VFD)**. These are types of display you commonly find on home appliances such as your cooker or microwave, and are used to communicate information such as cooking time and temperature.

Buffered I/O

The input/output ports on the Gertboard are where you will connect up your buttons and LEDs. These are controlled via jumpers which set the port to input or output mode.

The button, for example, is an input mechanism and the LED an output. Switching on an LED will result in sending the command from the Raspberry Pi via an output to the Gertboard as an input.

A push button works opposite to this, whereby an input from the button is sent to the Gertboard, and an output from the Gertboard is received as an input to the Raspberry Pi.

When using jumpers, it is important to think of the above in the following terms. An input jumper means an input to the Raspberry Pi, and an output jumper means an output from the Raspberry Pi.

Atmel ATmeg chip microcontroller

This device is the microcontroller for the Gertboard. The microcontroller is a single integrated computer that controls input and output of the devices on the Gertboard.

The development language for the Arduino can be used with the Gertboard. Once you have this installed, you can re-use Arduino-specific applications with a few changes or write new ones to control the Gertboard's microcontroller.

Convertors – analog to digital and digital to analog

ADC (Analog to Digital Convertor) and DAC (Digital to Analog Convertor) are used to convert data from one format to the other. They have applications in music recording and video, as well as being useful for converting analog readings from thermostats into digital readings.

You will be familiar with this concept from the projects you worked on in *Chapter 4, Our First Project – A Basic Thermometer*, *Chapter 5, From Thermometer to Thermostat – Building upon Our First Project*, and *Chapter 7, Curtain Automation – Open and Close the Curtains Based on the Ambient Light*.

For those interested in a more in-depth look at the Gertboard, the user manual is located on the Element14 website. The Gertboard user manual provides an in-depth look at the electronic components that come as part of the kit and is available at the following URL:

http://www.element14.com/community/servlet/JiveServlet/downloadBody/48860-102-3-256002/Gertboard_User_Manual_Rev_1%200_F.pdf

The Gertboard assembly manual is also available online at Element14 and provides an easy step-by-step guide to assembling the kit. You can view the assembly manual at the following URL:

http://www.element14.com/community/servlet/JiveServlet/downloadBody/48916-102-1-256003/Gertboard_Assembly_Manual_Rev1.1_F.pdf

Writing software for the Gertboard

There are several example programs written for the Gertboard in C that you may be interested in checking out. These can be downloaded from Element14 at the following URL:

<http://www.element14.com/community/solutions/6438/1/gertboard-application-library-for-gertboard-kit-linux>

These applications can be opened in Geany and compiled via a makefile.

Gordon Henderson's website also provides a guide to installing the Arduino IDE onto the Raspberry Pi and configuring it to work with the Gertboard. The instructions can be found at the following URL:

<https://projects.drogon.net/raspberry-pi/gertboard/>

So with two new boards to explore and some different libraries, let's look at some future projects that can leverage your existing hardware or use one of the other shields we have looked at.

Ideas for next step projects

This book has provided you with a variety of projects that provide tools for sensing and automating your home environment.

Armed with the knowledge from completing these projects, you are now equipped with the skills to expand your existing projects and create exciting new devices.

This list provides some potential projects for the future.

Expanding the curtain automation tool to include temperature sensing

Your current application from *Chapter 7, Curtain Automation – Open and Close the Curtains Based on the Ambient Light*, uses light to decide when to open and close the blinds/curtains.

You can now try combining the thermometer from *Chapter 4, Our First Project – A Basic Thermometer* with curtain-control device and re-write the software to incorporate temperature data.

Using the thermistor, you can decide to open and close your blinds if the temperature changes in order to conserve heat.

By expanding the database written in *Chapter 6, Temperature Storage – Setting up a Database to Store Your Results*, we can also record the times when the curtains are opened or closed, to give us an idea of how many hours of sunlight we received across a day in a certain month of the year.

This project would need no further components than those used in *Chapter 4, Our First Project – A Basic Thermometer* and *Chapter 7, Curtain Automation – Open and Close the Curtains Based on the Ambient Light*.

Changing the motor on the curtain automation project to a stepper motor

We currently use a small DC motor in *Chapter 7, Curtain Automation – Open and Close the Curtains Based on the Ambient Light*, in order to control the blinds in the project.

We can replace the regular DC motor with a DC stepper motor.

A stepper motor is a motor that divides a full revolution into *steps*. This allows greater control over the revolutions of the motor when it is operating and thus a greater point of accuracy when controlling the drawstring.

Switching lights on with a photoresistor

We learned how to switch on a fan using relays and a thermistor. The principles used in this project can be applied to a desktop lamp or similar lighting device. Using the relay shield and the photoresistor, we can change out thermostat application to switch on the lighting device when the room gets dark.

Holiday lights from LEDs

One application of the PWM code we wrote in *Chapter 7, Curtain Automation – Open and Close the Curtains Based on the Ambient Light*, is to cause LEDs to fade in and out. This provides us with the technology to make holiday lights that can blink and fade along to a pattern. To build on this project, you can time the lights to switch on and off in synchronization with music to provide an even more interesting experience.

The future of home automation

The Raspberry Pi and Arduino have provided us with two great technologies to create home automation projects. As the technology continues to grow, the tasks we will be able to achieve at home using homebrew devices will grow ever larger.

Lets take a look of some of the other tools that will become increasingly available to home enthusiasts.

3D printing

Rapid prototyping, commonly known as 3D printing, is a method of taking a 3D image and then printing it out in a substance such as plastic or metal.

The advent of cheaper 3D printing is providing home automation enthusiasts with a new tool in their arsenal. 3D printing's ability to create custom cases and brackets for devices and to then print these out in plastic provides a gateway to a whole new world of exciting designs.

Printers such as the Makerbot have opened up 3D printing to the home market. For those who can't afford a 3D printer at home, services such as Shapeways at www.shapeways.com/ provide a service that allows the customer to upload a 3D image to the website. Shapeways will then take this 3D image and print the object in a variety of materials and then ship it.

Raspberry Pi cases are a popular offer on their website!

[ Check out the Makerbot at <http://www.makerbot.com>.]

RFID chips

Radio Frequency Identification (RFID) is a method where microchips are embedded into items such as passports. When these chips are read, they provide information encoded in them.

Consumer goods are increasingly approaching the realm where embedded RFID chips will become commonplace.

When this takes place, home automation devices will be able to read the frequencies of products that enter the house and leave. Thus, a system can be built that reads the signals and adds to an inventory the groceries you have brought home.

On throwing out the empty cans and packaging, the inventory system will be able to track these leaving the kitchen and remove them from the database.

Therefore, inventory management of goods in the home will become an almost seamless process.

EEG headsets

EEG headsets are devices that allow people to interact with their computers through thought. This sounds like something from science fiction; however, products such as the Emotiv headset (refer <http://www.emotiv.com/>) and the upcoming Interaxon Muse (refer <http://www.indiegogo.com/interaxonmuse>) are carving the way for home EEG devices.

As software becomes widespread for EEG devices, it will only be a matter of time before home automation projects are touched by this technology.

The ability to *think* the lights on is going to provide home automation enthusiasts with plenty of exciting projects. A benefit of this will also be for the disabled, who will be provided with ways to interact with their home.

With technologies such as these on the horizon, we believe there will be many great opportunities to leverage the power of the Raspberry Pi and many exciting projects for enthusiasts such as you.

Summary

The Raspberry Pi is an inexpensive computer with a lot of potential. By choosing this technology, you have provided yourself with a fantastic tool to build home automation projects.

In this book, we have aimed to provide you with examples that are useful and slowly build up in difficulty, expanding your knowledge of the Raspberry Pi, Arduino, Linux, and related technologies along the way.

Our projects have covered the application of the Raspberry Pi in home automation and how we can leverage the existing Arduino toolset to augment the Raspberry Pi's abilities. As newer and more powerful versions are released, we believe the future for this technology is, indeed, very bright.

The Raspberry Pi community is growing by the day, and the best place to share your projects and look for help is at the Raspberry Pi website forum at <http://www.raspberrypi.org/phpBB3/>.

The Arduino community is well established and like the Raspberry Pi website, has a lively forum where you can turn for help at <http://arduino.cc/forum/>.

We started the book by looking at the history of home automation, and finished by looking at the future.

With this information, it is now over to you, the reader, to continue your journey.

References

In the appendix, we will cover some links and resources that will be useful for you for future projects and will help you learn more about the technologies used in this book.

These links cover a variety of sites, including commercial and open source. You will also find URLs that provide further information on some of the commands and programming languages we have used.

Raspberry Pi

The following links provide information and support for the Raspberry Pi and Raspbian operating system:

- Official Raspberry Pi website: <http://www.raspberrypi.org/>
- Official Raspberry Pi forum: <http://www.raspberrypi.org/phpBB3/>
- Raspbian website: <http://www.raspbian.org/>
- BerryBoot: <http://www.berryterminal.com/doku.php/berryboot>
- WiringPi library:
<https://projects.drogon.net/raspberry-pi/wiringpi/>
- WiringPi downloads: <https://github.com/WiringPi/WiringPi>
- Gertboard user manual: http://www.element14.com/community/servlet/JiveServlet/downloadBody/48860-102-3-256002/Gertboard_User_Manual_Rev_1%200_F.pdf
- eLinux Raspberry Pi Hub: http://elinux.org/RPi_Hub

Raspberry Pi to Arduino bridge shield

Information on the Cooking Hacks Raspberry Pi to Arduino Bridge can be found at the following locations:

- Cooking Hacks website: <http://www.cooking-hacks.com/>
- Raspberry Pi to Arduino tutorial: <http://www.cooking-hacks.com/index.php/documentation/tutorials/raspberry-pi-to-arduino-shields-connection-bridge>
- arduPi library board revision 1: http://www.cooking-hacks.com/skin/frontend/default/cooking/images/catalog/documentation/raspberry_arduino_shield/arduPi_rev1.tar.gz
- arduPi library board revision 2: http://www.cooking-hacks.com/skin/frontend/default/cooking/images/catalog/documentation/raspberry_arduino_shield/arduPi_rev2.tar.gz

Linux

There are a wide range of resources available for Linux online. The following links provide some overviews of commands and packages used in this book:

- Screen user's manual:
<http://www.gnu.org/software/screen/manual/screen.html>
- Raspbian package information: <http://elinux.org/Raspbian>
- apt-get user manual: <http://linux.die.net/man/8/apt-get>
- Wget user manual:
<http://www.gnu.org/software/wget/manual/wget.html>
- Linux Kernel Archive: <http://www.kernel.org/>
- Geany IDE: <http://www.geany.org/>
- Make command manual: <http://linux.die.net/man/1/make>
- Chmod manual page: <http://linux.die.net/man/1/chmod>
- Chown manual page: <http://linux.die.net/man/1/chown>

Python

A variety of Python resources that are useful to you, including information on the WSGI technology, are available at the following links:

- Official Python website: <http://www.python.org/>
- Python documentation: <http://docs.python.org/>
- WSGI homepage: <http://www.wsgi.org/>
- Python pip: <http://pypi.python.org/pypi/pip>
- Download Python: <http://www.python.org/getit/>

C/C++

The following collection of links provide further information on the C and C++ programming languages:

- C and C++ programming reference: <http://www.cprogramming.com/>
- POSIX threads: <https://computing.llnl.gov/tutorials/pthreads/>
- G++ compiler: <http://linux.die.net/man/1/g++>

Arduino

We have provided some useful resources on the Arduino hardware and software that you can use to learn more about the open source technology:

- Official Arduino homepage: <http://www.arduino.cc/>
- Official Arduino forum: <http://arduino.cc/forum/>
- Official Arduino store: <http://store.arduino.cc/>
- Arduino IDE downloads: <http://arduino.cc/en/Main/Software>
- Arduino hardware:
<http://arduino.cc/en/Main/Products?from=Main.Hardware>
- Makezine Arduino blog: <http://blog.makezine.com/arduino/>

SQL

There are a variety of flavors of SQL. The following URLs are geared towards SQLite that we used in this book for our temperature storage database:

- SQLite homepage: <http://www.sqlite.org/>
- SQLite downloads: <http://www.sqlite.org/download.html>
- SQLite Documentation: <http://www.sqlite.org/docs.html>
- W3 Schools SQL guide: <http://www.w3schools.com/sql/default.asp>

HTSQL

The following links provide an in-depth guide to HTSQL, as well as the HTRAF tools you can use to interact with an HTSQL server via your website:

- Official HTSQL website: <http://htsql.org/>
- HTSQL tutorial: <http://htsql.org/doc/tutorial.html>
- HTSQL downloads: <http://htsql.org/download/>
- HTRAF toolkit: <http://htraf.org>
- HTSQL Python page: <http://pypi.python.org/pypi/HTSQL>
- HTSQL mailing list:
<http://lists.htsql.org/mailman/listinfo/htsql-users>

Apache

There are many resources on Apache available online; these resources provide information on the web server, foundation, and common documentation:

- Apache foundation homepage: <http://www.apache.org/>
- Download apache: <http://www.apache.org/dyn/closer.cgi>
- Apache web server: <http://httpd.apache.org/>
- Apache documentation: <http://httpd.apache.org/docs/>
- Modwsgi: <http://code.google.com/p/modwsgi/>

Electronics

You can order electronic components online from a variety of sources. These URLs are for major suppliers who stock the components used in this book. We also provide some links to basic electronic guides:

- Adafruit industries: <http://www.adafruit.com/>
- Cooking Hacks: <http://www.cooking-hacks.com/>
- Makeshed: <http://www.makershed.com/>
- Element14: <http://www.element14.com/>
- RS Components: <http://www.rs-components.com>
- Making Things introduction to electronics: http://www.makingthings.com/teleo/products/documentation/teleo_user_guide/electronics.html
- Wikipedia article on electronic symbols: http://en.wikipedia.org/wiki/Electronic_symbol

Packt Publishing titles

Packt Publishing has a variety of books on many of the technologies used in this book. We provide links to titles that may interest you:

- Packt Publishing homepage: <http://www.packtpub.com/>
- Expert Python Programming:
<http://www.packtpub.com/expert-python-programming/book>
- Linux shell scripting cook book:
<http://www.packtpub.com/linux-shell-scripting-cookbook/book-0>
- CherryPy Essentials Rapid Python Web Application development:
<http://www.packtpub.com/CherryPy/book>

Home automation technology

For those interested in commercial and open source home automation applications and technology, we have provided several resources including those related to X10.

- X10 knowledge base: http://kbase.x10.com/wiki/Main_Page
- X10.com: <http://www.x10.com/homepage.htm>
- Nest Learning Thermostat: <http://www.nest.com/>
- Android operating system: <http://www.android.com/>

- Android developer resources: <http://developer.android.com/index.html>
- Open source automation (Windows based):
<http://www.opensourceautomation.com/>
- Open Remote: <http://www.openremote.org/display/HOME/OpenRemote>
- Honeywell for your home: <http://yourhome.honeywell.com/home/>
- Hackaday blog: <http://hackaday.com/>
- Iris Smart Kit: http://www.lowes.com/cd_Products_1337707661000_

3D printing

3D printing will provide home automation enthusiasts with the tools to build custom cases, brackets, gears, and other tools for their systems. The following links cover 3D printers and 3D printing services:

- Makerbot 3D printers: <http://www.makerbot.com/>
- Thingiverse: <http://www.thingiverse.com/>
- Shapeways 3D printing on demand: <http://www.shapeways.com/>
- Stratasys 3D printers: <http://www.stratasys.com/>
- i.materialise: <http://i.materialise.com/>
- Next Engine 3D scanner: <http://www.nextengine.com/>
- David 3D scanner: <http://www.david-laserscanner.com/>

EEG headsets

EEG headsets are an upcoming technology. The following resources provide links to devices that can be bought and developed against:

- Emotiv headset: <http://www.emotiv.com/>
- Neurosky: <http://www.neurosky.com/>
- Interaxon Muse: <http://interaxon.ca/muse/faq.php>
- EEG article on Wikipedia:
<http://en.wikipedia.org/wiki/Electroencephalography>

Miscellaneous resources

We also provide a list of miscellaneous resources based on some of the topics touched upon in this book, and other areas of interest:

- Popular mechanics back issues at Google books: http://books.google.com/books?id=49gDAAAAMBAJ&source=gbs_all_issues_r&cad=1&atm_aiy=1960#all_issues_anchor
- Wikipedia article on mains electricity: http://en.wikipedia.org/wiki/Mains_electricity
- Wikipedia article on relays: <http://en.wikipedia.org/wiki/Relay>
- Wikibooks embedded systems: http://en.wikibooks.org/wiki/Embedded_Systems
- Open Source Initiative: <http://opensource.org/>
- IO programming language: <http://iolanguage.org/>
- IO programming language Raspberry Pi binary: <http://iobin.suspended-chord.info/linux/iobin-linux-armhf-deb-current.zip>

Index

Symbols

- 3.5mm analog audio jack, Raspberry Pi** 10
- 3D printing**
 - about 139, 148
 - online resources 148
- 10K Ohm resistor**
 - about 56
 - Wikipedia URL 56
- 256 MB/512 MB SD RAM shared with GPU, Raspberry Pi** 11

A

- Adafruit industries**
 - URL 147
- ADC (Analog to Digital Converter)** 137
- addtemperature.wsgi** 100
- analog inputs, Raspberry Pi to Arduino shield** 15
- analogRead() function** 66
- Android developer resources**
 - URL 148
- Android operating system**
 - URL 147
- Apache**
 - download link 146
 - online resources 146
- apachectl graceful command** 95
- apachectl graceful-stop command** 96
- apachectl restart command** 95
- apachectl start command** 95
- apachectl stop command** 95
- Apache documentation**
 - URL 146
- Apache foundation homepage**
 - URL 146
- Apache Version 2.x**
 - using 94
- Apache web server**
 - about 89, 94
 - commands 95
 - conclusion 104
 - setting up 94-97
 - URL 146
 - WSGI 97
- apt-get user manual**
 - URL 144
- Arduino**
 - background 12, 13
 - benefit 13
 - history 12
 - online resources 145
 - software, writing for 16
 - URL 43, 145
- Arduino forum**
 - URL 145
- Arduino hardware**
 - URL 145
- Arduino IDE**
 - Arduino language 43, 44
 - installing 42
- Arduino IDE downloads**
 - URL 145
- Arduino language**
 - about 16, 44
 - features 44
 - HTSQL 16
 - Python 16
 - SQL 16

Arduino shields
about 12
testing, with database 108

Arduino store
URL 145

arduinoPi
about 45
installing 45

arduinoPi library board revision 1
URL 144

arduinoPi library board revision 2
URL 144

arduinoPi software 13

Atmel ATmeg chip microcontroller 137

B

BerryBoot
about 24, 28
URL 143
zip file, downloading 28

BETA constant 63

blinking LED application
about 48
code 49
compiling 50
running 50

breadboard
using 56

buffered I/O 136

byte val0 variable 64

byte val1 variable 64

C

C/C++
online resources 145
programming reference 145

CherryPy Essentials Rapid Python Web Application development
URL 147

Chmod manual page
URL 144

Chown manual page
URL 144

commands, Apache web server
apachectl graceful 95
apachectl graceful-stop 96

apachectl restart 95
apachectl start 95
apachectl stop 95

components, Gertboard. See Gertboard components

composite RCA port, Raspberry Pi 10

constants
BETA 63
READINGS 63
ROOMTEMPK 63
TENKRESISTOR 63
THERMISTOR 63

contact points, relay
Common Connection 74
Normally Closed 74
Normally Open 74

controlMotor() function 124

Cooking Hacks
about 13
URL 13, 40, 144, 147

Cooking Hacks shield 13

core-components, Raspberry Pi
3.5mm analog audio jack 10
256 MB/512 MB SD RAM shared
with GPU 11
composite RCA port 10
CPU 11
dimensions 10
Ethernet port 12
GPIO pins 12
GPU 11
HDMI port 11
micro USB port 10
SD card port 11
USB 2.0 ports 10

CP-290 unit 18

CPU, Raspberry Pi 11

cURL 79

curlInst variable 82

curtain automation tool
expanding, for including temperature sensing 138
motor, changing to stepper motor 139

curtain control application
about 119
blinds/curtains, connecting to 125
code, writing 120-123

- debugging 125
- hardware, attaching 126
- problems, debugging 126
- PWM 119
- threads 119
- timing, setting 125

curtaincontrol program
launching 126

D

DAC (Digital to Analog Converter) 137

database, SQLite
creating 91
table, creating for recording rooms 92
table, creating for recording temperature 91

David 3D scanner
URL 148

digital I/O pins, Raspberry Pi to Arduino shield 14

digitalWrite() function 47

dimensions, Raspberry Pi 10

domotics 17

E

ECHO 17

EEG article on Wikipedia
URL 148

EEG headsets
about 148
online resources 148

EEG Headsets 140, 141

Electronic Computing Home Operator. See ECHO

electronics
online resources 147

Element14
URL 147

eLinux Raspberry Pi Hub
URL 143

Emotiv headset
URL 140, 148

Ethernet port, Raspberry Pi 12

except statement 103

Expert Python Programming
URL 147

F

FAT 24

File Allocation Table. See FAT

flaws, X10 technology standard 18

float avResistance variable 64

float celsius variable 64

float fahrenheit variable 64

float kelvin variable 64

float resistance variable 64

G

G++ compiler
URL 145

Geany IDE
about 58
installing 58, 59
URL 144

Gertboard
about 134
components 134

Gertboard components
about 134
ADC 137
Atmel ATmeg chip microcontroller 137
buffered I/O 136
DAC 137
GPIO expansion board 135
GPIO Pins 135
kit and pre-soldered board 135
motor controller 136
open collector drivers 136
software, writing 137

Gertboard user manual
URL 143

GPIO expansion board 135

GPIO pins 135

GPIO pins, Raspberry Pi 12

GPU, Raspberry Pi 11

H

Hackaday blog
URL 148

hardware components, thermometer
10K Ohm resistor 56

- breadboard 56
- connecting 56, 57
- resistors 55
- setting up 54
- thermistor 55
- wires 56
- hardware components, thermostat**
 - about 73
 - relay 74
- HDMI port, Raspberry Pi 11**
- High Definition Multi-media Interface port.**
See **HDMI port**
- holiday lights**
 - from LEDs 139
- home automation**
 - 3D printing 139
 - about 17
 - commercial products 20
 - dot.com boom 19
 - EEG Headsets 140
 - future 139
 - history 17
 - online resources 147
 - open source technologies 19
 - RFID chips 140
 - X10 technology standard 18
- Honeywell**
 - URL 148
- HTRAF toolkit**
 - URL 146
- HTSQL**
 - about 16, 104
 - configuring 106-108
 - downloading 105
 - online resources 146
 - URL 146
- HTSQL downloads**
 - URL 146
- HTSQL mailing list**
 - URL 146
- HTSQL Python page**
 - URL 146
- HTSQL tutorial**
 - URL 146
- Hyper Text Structured Query Language.** *See*
HTSQL

I

- ICSP connector, Raspberry Pi to Arduino shield 15**
- i.materialise**
 - URL 148
- include statement 49**
- installation**
 - Geany IDE 58, 59
 - SQLite 90
- Interaxon Muse**
 - URL 140, 148
- int main(){} function 47**
- Iris Smart Kit**
 - URL 148

L

- Leafpad**
 - about 46
 - loading 46, 47
- lights**
 - switching on, with photoresistor 139
- Linux**
 - online resources 144
 - SD card formatting instructions 27
 - URL 37
 - URL, screen users manual 144
 - zipping tools, downloading 29
- Linux Kernel Archive**
 - URL 144
- Linux shell scripting cook book**
 - URL 147
- loop() function 47, 68**
- LXTerminal**
 - about 34
 - loading 34

M

- Mac and Linux users**
 - PuTTY, setting up 36
- Mac OS X**
 - Archiver, downloading 28
 - SD card formatting instructions 26
 - WinZip, downloading 28
- make command manual**
 - URL 144

Makefiles
about 59
creating 60
running 60

Makerbot
URL 140

Makerbot 3D printers
URL 148

Makeshed
URL 147

Makezine Arduino blog
URL 145

Making Things introduction to electronics
URL 147

micro USB port, Raspberry Pi 10

Midori 34

miscellaneous resources
reference link 149

Modwsgi
URL 146

motor controller 136

motor shield
components, wiring up 117
setting up 117

my_query variable 103

my_response variable 103

N

Negative Thermistor Coefficient (NTC) 55

Nest Learning Thermostat
URL 147

Neurosky
URL 148

Newark/Element14
URL 129

Next Engine 3D scanner
URL 148

O

Ohms 55

open collector drivers 136

Open Remote
URL 148

Open source automation
URL 148

P

Packt publishing homepage
URL 147

params variable 102

photoresistor
about 112
components, wiring up 113
debug 117
motor shield and motors 112
setting up 112
testing, with software 114, 116
using 112

Positive Thermistor Coefficient (PTC) 55

POSIX threads
URL 145

power pins, Raspberry Pi to Arduino shield 15

power source selector, Raspberry Pi to Arduino shield 14

pre-installed SD card
versus, blank SD card 24

printed circuit board (PCB) 134

Prototyping Pi Plate
about 131, 132
building 131
reviewing 130
URL 131

pthread library 119

Pulse Width Modulation. See PWM

PuTTY
about 35
on Mac and Linux users 36
on Windows 35, 36

PWM 119

Python
about 89
download link 145
online resources 145
URL 145

Python application
creating, for writing database 100-103

Python documentation
URL 145

Python IDE 34

Python pip

URL 145

Python script 16

Q

query_results variable 103

R

Radio Frequency Identification. *See* **RFID chips**

Raspberry Pi

arrival 21

background 8, 9

core-components 10

forum, URL 37

genesis 8

hardware specifications 9

history 8

hooking up 29

online resources 143

operating system, deciding 30

pre-installed SD card, versus blank SD card 24

SD card 23

SD card, setting up 24

setting up 23

URL 37, 143

Raspberry Pi forum

URL 143

Raspberry Pi GPIO connector 15

Raspberry Pi Prototyping Pi Plate shield

about 131

guide to soldering, URL 131

Raspberry Pi to Arduino shield

about 13

analog inputs 15

digital I/O pins 14

ICSP connector 15

key components 14

online resources 144

power pins 15

power source selector 14

Raspberry Pi GPIO connector 15

specifications 13

SPI pins 15

UART 14

using 39

XBee socket 14

Raspberry Pi to Arduino shield connection bridge 13

Raspberry Pi to Arduino shield set up

about 39

Arduino IDE, installing 42

arduPi, installing 45

blinking LED application 48

connecting up, to Raspberry Pi 41

LED, hooking up 41

Raspberry Pi version, checking 40

software, installing 42

Raspberry Pi to Arduino shield specifications 13

Raspberry Pi to Arduino tutorial

URL 144

Raspbian

about 30

features 30

installing 31-34

URL 37, 143

Raspbian Linux desktop 34

Raspbian package

URL 144

READINGS constant 63

relay

about 74

connecting 74, 75

contact points 74

testing 75

requestFrom() function 66

resistance 55

resistance readings

about 64

byte val0 64

byte val1 variable 64

float avResistance 64

float resistance 64

resistors 55

RFID chips 140

ROOMTEMPK constant 63

room variable 102

RS Components

URL 147

S

screen

installing 77, 79

SD card

about 23

formatting 25

formatting instructions for Linux 27

formatting instructions for Mac OS X 26

formatting instructions for Windows 7
25, 26

setting up 24

SD card port, Raspberry Pi 11

setpoint 72, 114

setup() function 47, 119

Shapeways

URL 140

Shapeways 3D printing

URL 148

software

writing, for Arduino 16

software components, thermostat

cURL 79

program, adding to test relay 75, 77

screen, installing 77, 78

setting up 75

thermostat code 79

software, thermometer

about 58

application, writing 61, 62

Geany IDE 58

Makefiles 59

thermometer code 61

soldering 15

SPI pins, Raspberry Pi to Arduino shield 15

SQL

about 16

online resources 146

using 16

writing 92, 93

SQLite

about 89

database, creating 91

loading 91

SQL, writing 92

URL 146

SQLite documentation

URL 146

SQLite downloads

URL 146

SQLite Version 3.x

about 89

installing 90

square wave 119

Stratasys 3D printers

URL 148

Structured Query Language. *See* SQL

T

temperature calculations

about 64

float celsius 64

float fahrenheit 64

float kelvin 64

temperature table

datetime 92

id 91, 92

roomid 91

roomname 92

temperaturef 92

temperature variable 102

TENKRESISTOR constant 63

thermistor

about 55

beta coefficient 55

coefficient 55

THERMISTOR constant 63

thermometer application

about 54

building 54

compiling 68

components, setting up 56

hardware, setting up 54

hardware setup, verifying 57, 58

running 70

software 58

testing 69

writing 61-67

thermometer code 61

thermostat

about 72, 73

- fan, attaching 86
- hardware setting up 73
- software, setting up 75
- testing 85
- thermostat application**
 - problems, debugging 87
 - running 86
- thermostat code**
 - modifying 79-85
- Thingiverse**
 - URL 148
- threshold 114**

U

- UART, Raspberry Pi to Arduino shield 14**
- USB 2.0 ports, Raspberry Pi 10**

V

- Vacuum Fluorescent Display (VFD) 136**
- void loop() function 44**
- void setup() function 44**

W

- W3 Schools SQL guide**
 - URL 146
- Web Server Gateway Interface. *See* WSGI**
- Wget user manual**
 - URL 144
- Wikipedia article on electronic symbols**
 - URL 147
- Windows**
 - 7-zip, downloading 28
 - PuTTY, setting up 35
 - SD card formatting instructions 25, 26
 - WinZip, downloading 28

WiringPi downloads

- about 133
- URL 143

WiringPi library

- URL 143

wiringPi webpage

- URL 133

wires 56

WSGI

- about 89
- setting up 98-100

WSGI homepage

- URL 145

X

X10.com

- URL 147

X10 knowledge base

- URL 147

X10 technology standard

- about 18
- flaws 18

Xbee sockets, Raspberry Pi to Arduino shield 14

Z

zip/unzip application

- downloading, for Linux 29
- downloading, for Mac OS X 28
- downloading, for Windows 28



Thank you for buying **Raspberry Pi Home Automation with Arduino**

About Packt Publishing

Packt, pronounced 'packed', published its first book "*Mastering phpMyAdmin for Effective MySQL Management*" in April 2004 and subsequently continued to specialize in publishing highly focused books on specific technologies and solutions.

Our books and publications share the experiences of your fellow IT professionals in adapting and customizing today's systems, applications, and frameworks. Our solution based books give you the knowledge and power to customize the software and technologies you're using to get the job done. Packt books are more specific and less general than the IT books you have seen in the past. Our unique business model allows us to bring you more focused information, giving you more of what you need to know, and less of what you don't.

Packt is a modern, yet unique publishing company, which focuses on producing quality, cutting-edge books for communities of developers, administrators, and newbies alike. For more information, please visit our website: www.packtpub.com.

Writing for Packt

We welcome all inquiries from people who are interested in authoring. Book proposals should be sent to author@packtpub.com. If your book idea is still at an early stage and you would like to discuss it first before writing a formal book proposal, contact us; one of our commissioning editors will get in touch with you.

We're not just looking for published authors; if you have strong technical skills but no writing experience, our experienced editors can help you develop a writing career, or simply get some additional reward for your expertise.



Linux Shell Scripting Cookbook

ISBN: 978-1-84951-376-0 Paperback: 360 pages

Solve real-world shell scripting problems with over 110 simple but incredibly effective recipes

1. Master the art of crafting one-liner command sequence to perform tasks such as text processing, digging data from files, and lot more
2. Practical problem solving techniques adherent to the latest Linux platform
3. Packed with easy-to-follow examples to exercise all the features of the Linux shell scripting language



Raspberry Pi Media Center

ISBN: 978-1-78216-302-2 Paperback: 100 pages

Transform your Raspberry Pi into a full-blown media center within 24 hours

1. Discover how you can stream video, music, and photos straight to your TV
2. Play existing content from your computer or USB drive
3. Watch and record TV via satellite, cable, or terrestrial
4. Build your very own library that automatically includes detailed information and cover material

Please check www.PacktPub.com for information on our titles

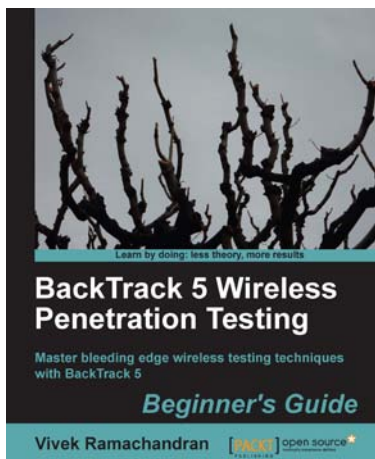

BackTrack 5 Wireless Penetration Testing Beginner's Guide

ISBN: 978-1-84951-558-0 Paperback: 220 pages

Master bleeding edge wireless testing techniques with BackTrack 5

1. Learn Wireless Penetration Testing with the most recent version of Backtrack
2. The first and only book that covers wireless testing with BackTrack
3. Concepts explained with step-by-step practical sessions and rich illustrations



Metasploit Penetration Testing Cookbook

ISBN: 978-1-84951-742-3 Paperback: 268 pages

Over 70 recipes to master the most widely used penetration testing framework

1. More than 80 recipes/practical tasks that will escalate the reader's knowledge from beginner to an advanced level
2. Special focus on the latest operating systems, exploits, and penetration testing techniques
3. Detailed analysis of third party tools based on the Metasploit framework to enhance the penetration testing experience

Please check www.PacktPub.com for information on our titles